



**TORUS
POWER™**

Toroidal

Isolation

Power

Conditioning

AVR Series Manual

**Audio / Video Power Isolation Units
with Automatic Voltage Regulation**

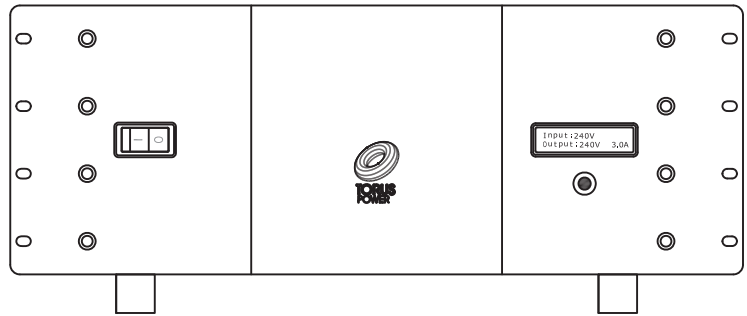

19" Pro Series Rack Mount (RK) Faceplate

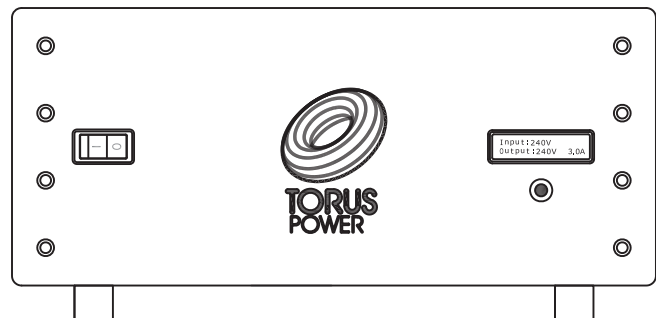

17" Consumer Series (C) Faceplate
Available in Black (B) and Silver (S) Colours

Table of Contents

Table of Contents	Page 1
Important Safety Instructions	Page 2
Shipping Carton & Packing Material	Page 2
Torus Power AVR Series Power Conditioners - User Notes and Manual	Page 3
Front Panel Display	Page 4
Rear Panel Connections and AVR Software	Page 5
AVR Software - Menu Selection	Page 6,7,8
Block Diagram - AVR System Layout	Page 9
Schematic North American Model	Page 10
Schematic International Model	Page 10
North American Model Numbers	Page 11
International Model Numbers	Page 11
Typical front Panel Layout of North American and International Models	Page 12
Electrical Specifications North American Models	Page 12
Mechanical Specifications North American Models	Page 12
Line Cords and Wall Receptacles for North American Models	Page 13
Rear Panel Layout of North American Models	Page 13
Electrical Specifications International Models	Page 14
Mechanical Specifications International Models	Page 14
Rear Panel Layout of International Models	Page 15
Home Automation Interface	Page 16
Warranty	Page 16



Important Safety Instructions

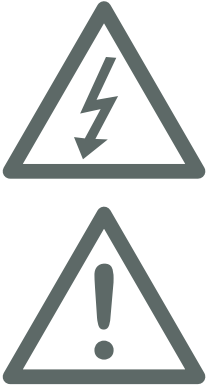

CAUTION! To reduce the risk of electric shock and fire, do not remove the cover of this device. There are no user serviceable parts inside. Please refer all servicing to licensed service technicians.

CAUTION! The international symbol of a lightning bolt inside a triangle is intended to alert the user to uninsulated "dangerous voltage" within the device's enclosure. The international symbol of an exclamation point inside a triangle is intended to alert the user to the presence of important operating, maintenance and servicing information in the manual accompanying the device.

CAUTION! To prevent electrical shock, match wide blade of plug to wide slot, fully insert.

CAUTION! To reduce the risk of electrical shock, do not expose this equipment to rain or moisture.

1. Read Instructions—All safety and operating instructions should be read before operating the device.
2. Retain Instructions—The safety and operating instructions should be retained for future reference.
3. Heed Warnings—All warnings on the device and in the operating instructions should be adhered to.
4. Follow Instructions—All operating and safety instructions should be followed.
5. Water & Moisture—The device should never be used in, on or near water for risk of fatal shock.
6. Ventilation—The device should always be located in such a way that it maintains proper ventilation. It should never be placed in a built-in installation or anywhere that may impede the flow of air through its ventilation slots.
7. Heat—Never locate the device near heat sources such as radiators, floor registers, stoves or other heat-generating devices.
8. Power Cord Protection—Power cables should be routed so they are not likely to be stepped on or crushed by items placed on them or against them. Special attention should be paid to areas where the plug enters a socket or fused strip and where the cord exits the device.
9. Periods Of Non-Use—The device should be unplugged when not being used for extended periods.
10. Dangerous Entry—Care should be taken that no foreign objects or liquids fall or are spilled inside the device.
11. Damage Requiring Service—The device should be serviced by licensed technicians when:
 - The plug or power supply cord has been damaged.
 - Objects have fallen or liquid has spilled inside the device.
 - The device has been exposed to moisture.
 - The device does not appear to be operating properly or exhibits a marked change in performance.
 - The device has been dropped or the enclosure becomes damaged.
12. Service—The device should always be serviced by licensed technicians. Only replacement parts specified by the manufacturer should be used. The use of unauthorized substitutions may result in fire, shock, or other hazards.
13. Do not position the equipment so that it is difficult to operate the disconnecting device (power cord).
14. If the equipment is used in a manner not specified by the manufacturer, the protection provided by the equipment may be impaired.
15. The power switch should be in the "off" position when connecting or disconnecting equipment from a Torus Power unit.
16. **CAUTION** Some units can be very heavy, please use safe practices when lifting.



≥18 kg (39.7 lb)



≥32 kg (70.5 lb)

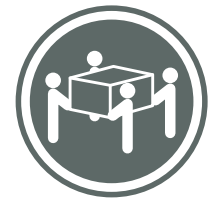

≥55 kg (121.2 lb)

Shipping Carton & Packing Material

Please keep the original shipping box and all packing material. This will ensure the AVR is protected in future transport.

In the unlikely event you have a problem and must return it for service you must use the original packing material.

Ship the AVR only in the original packing material, as the unit is not insurable by carriers otherwise.



Placement and ventilation

Allow 1" distance on all sides when positioning the AVR for proper ventilation, and allow 6" behind the AVR for adequate wiring space. Do not place heat-generating devices directly below the AVR.

Connecting components and using the AVR

Using the AVR is as simple as plugging in audio and video components to the outlets on the rear panel. The order and position in which you connect your components will not affect the performance of the AVR or your components. Connect the AVR to the wall outlet, and switch it on. Turn on the components individually.

While the AVR has built-in software that can be accessed via the Ethernet connection, there is no need for you to use this software. The AVR system provides all the standard features, performance, and benefits out - of - the - box by simply plugging it in as described in this section. You can use the AVR software to monitor the voltage conditions via your computer, and for such additional features as being able to turn your system on/off remotely and change the duration of the display's backlight.

Torus AVR – Description

Torus Power AVR (Automatic Voltage Regulation) is a full-feature state-of-the-art power conditioner, isolating and protecting your system. Like all Torus Power products, the AVR series provides true isolation (using massive toroidal transformers) and protects all connected equipment from the risk of severe power line surges using series-mode surge suppression. In addition, Torus AVR provides stable voltage to keep equipment running in the optimal range of 115VAC to 125VAC for any input voltage from 90V to 130VAC. (International units operate within nominal input voltage such as 220V, 230V, 240V; Torus AVR keeps them operating within a range of +/- 10V.) See table on Page 9 for more details.

Torus Power AVR series uses a micro-processor to monitor and control the power provided to connected components. The front panel display on the Torus Power AVR indicates input and output voltages, and displays output current, as well as displaying fault conditions.

The Torus Power AVR is pre-programmed to power down the system when a high or low fault conditions occurs (user can over-ride).

There are multiple interfaces built into the Torus Power AVR:

- 1) Ethernet interface with built-in web server allows any computer to view voltage and current readings and turn the AVR unit on or off.
- 2) RS-232 is provided for connection to media control systems.
- 3) Two 12V triggers are provided.

Does your system need automatic voltage regulation?

Under ideal conditions, when the supplied power line is stable and dependable, you may not need voltage regulation. In such an ideal situation, your equipment can operate within the normal tolerance of the line voltage.

In reality, the power supplied to most areas is less than ideal due to outdated power grids. In most areas, the power regularly drops or rises beyond the acceptable range (in North America +/- 5V, Europe/Asia/Australia +/- 10V) . These voltage sags, brownouts, and surges can stress components and shorten equipment life. In the worst case, catastrophic events can destroy valuable equipment. In such real-world conditions, Torus Power AVR can protect your equipment, and improve the quality and enjoyment of your audio and video experience.



Front Panel Display

Front Panel

The Front Panel display consists of a 2 line LCD and 1 push button.

Typical display.

```
In: 115V
Out: 120V 5.2A
```

Press button to show IP Address. (If ethernet connection is used)

```
IP Address
10.1.1.112
```

See section on AVR software for further information on the IP Address.

Voltage Faults

If a high or low voltage condition exists for 30 seconds or more, a voltage fault is displayed and the fault output is turned on and the system shuts down (unless over-ridden by the user).

Display will show

```
System OFF
LOW AC VOLTAGE
```

Or

```
System OFF
HIGH AC VOLTAGE
```

As the output power from the Torus Power AVR is shut down, all the connected equipment is turned off. The AVR power switch remains in the ON position, although there is no power to the load.

The connected equipment should be switched off.

When the voltage has been restored to the normal operating range, the following procedure can be followed:

- The Torus Power AVR can be switched OFF and then ON.
- Wait thirty seconds to verify the fault condition no longer exists.
- The connected equipment should be switched on individually.

If the fault condition still exists, the AVR will require approximately 15 seconds to monitor the incoming voltage, and the system will shut down again.

The user can program the AVR software to allow the system to remain on, in case of fault (see AVR software section for details).



Rear Panel Connections and AVR Software

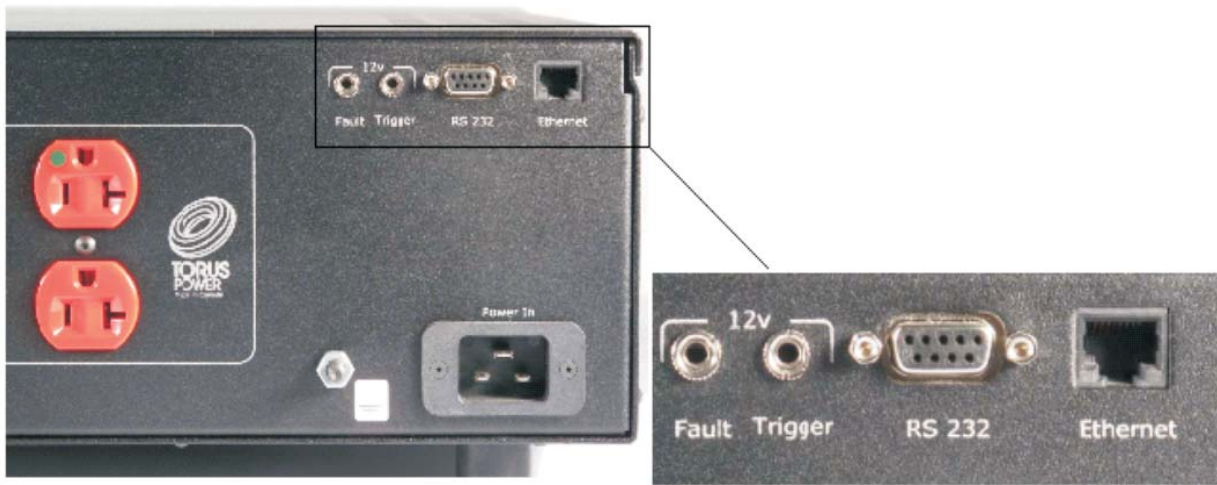

Figure 1: AVR Rear Panel connections.

Ethernet

Allows access to the AVR and internal software. See AVR Software section for more details.

RS232

Allows access to automation and external control. See Home Automation Interface commands at end of manual.

12V Trigger On/Off

The AVR can be turned on and off by a 12 volt trigger input. Applying 12 volts turns on the AVR and removing the 12 volts turns it off.

12V Fault Output

The AVR provides a 12 volt fault output through a jack on the back panel. The output goes to 12 volts when a relay or voltage fault is detected. The maximum current that can be drawn from this output is 75 mA.

AVR Software

AVR software is resident in the microprocessor on the internal control board. There are two methods to access the software.

- 1) Connect the AVR to the Ethernet port. Open a browser window on a PC that is connected to the same network through another Ethernet port. Enter AVR (or the I.P address displayed on the LCD) into the browser window. Press ENTER and the software will open.
- 2) Use a three way Hub, which is connected to an existing network. You then connect both PC and AVR to the same Hub. Open a browser window from the PC. Type AVR, (or the I.P address displayed on the LCD) into the browser window. Press ENTER and the software will open.

Username and Password

The password is required to change the setup of the Torus unit.

Username is **admin** This is factory set and cannot be changed

Password is **avr** This is the default password, and can be changed.

In case you forget your password, the AVR can be restored to the factory default password **avr** by pressing and holding the button on the front panel for at least 10 seconds.





AVR Menu Selections

- AVR Status
- Switch Power
- Setup
- Email Configuration
- Set Password
- Torus Power Home (website)
- Network configuration

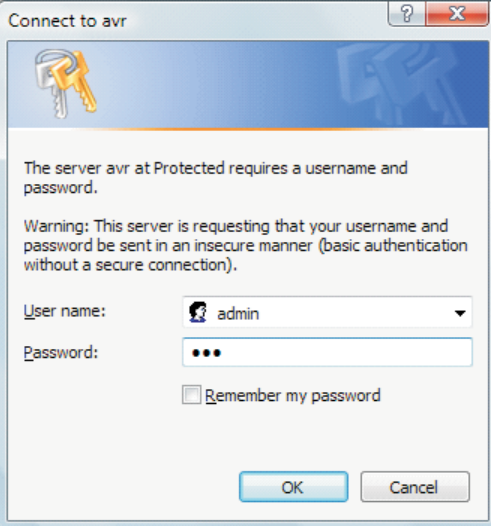
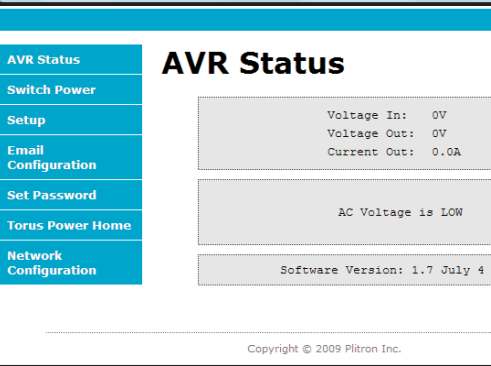
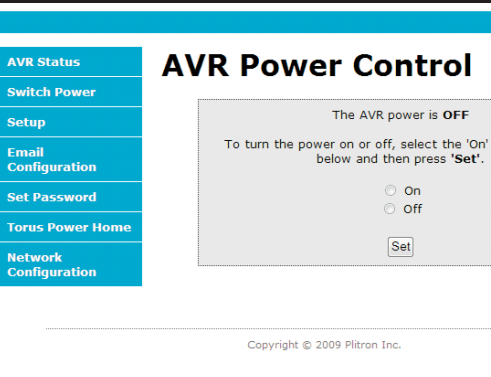
Below is a screen by screen description of software options.

	<p>To access AVR software, enter user name and password.</p> <p>User name :</p> <p>admin</p> <p>is factory set and cannot be changed</p> <p>Default Password :</p> <p>avr</p> <p>You can change your password. Select Set Password</p>
	<p>AVR Status</p> <p>This screen indicates the overall status of the system, showing Voltage In, Voltage Out, and Current output.</p> <p>It also reports if the system is functioning normally or whether there is a fault condition.</p>
	<p>AVR Power Control</p> <p>This screen allows ON or OFF control of the AVR unit.</p> <p>Press SET button to implement your selection.</p>

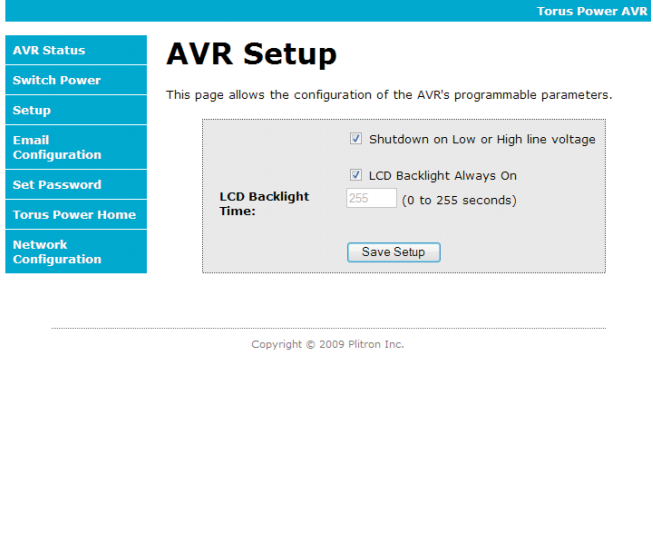
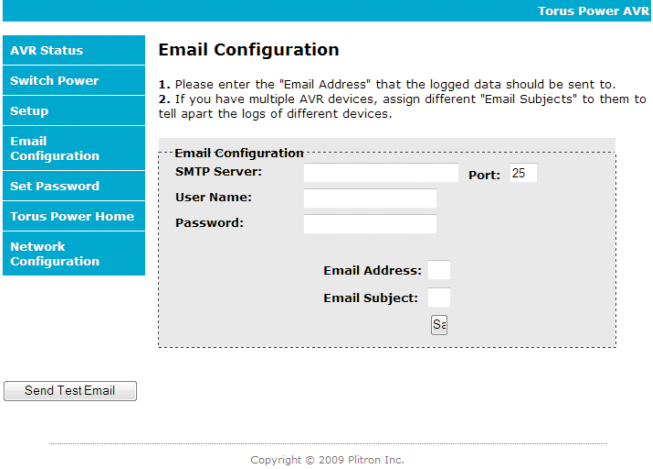

 <p>AVR Setup</p> <p>This page allows the configuration of the AVR's programmable parameters.</p> <p><input checked="" type="checkbox"/> Shutdown on Low or High line voltage</p> <p><input checked="" type="checkbox"/> LCD Backlight Always On</p> <p>LCD Backlight Time: <input type="text" value="255"/> (0 to 255 seconds)</p> <p><input type="button" value="Save Setup"/></p> <p>Copyright © 2009 Plitron Inc.</p>	<h3>AVR Setup</h3> <p>This screen allows the user to configure two AVR parameters.</p> <ol style="list-style-type: none"> Shutdown on Low or High line voltage. (The factory default is YES – to shut down in case of fault conditions.) Unselecting this button will override, and the AVR will remain on even if voltage drops or rises beyond the acceptable range. LCD Display. Always ON is the default setting. If you don't want the display on all the time, you can select a time from 0 to 255 seconds. When you have made your selections, press SAVE SETUP.
 <p>Email Configuration</p> <p>1. Please enter the "Email Address" that the logged data should be sent to. 2. If you have multiple AVR devices, assign different "Email Subjects" to them to tell apart the logs of different devices.</p> <p>Email Configuration</p> <p>SMTP Server: <input type="text"/> Port: 25</p> <p>User Name: <input type="text"/></p> <p>Password: <input type="password"/></p> <p>Email Address: <input type="text"/></p> <p>Email Subject: <input type="text"/></p> <p><input type="button" value="Send Test Email"/></p> <p>Copyright © 2009 Plitron Inc.</p>	<h3>Email Fault Alert Notification</h3> <p>In the unlikely event your AVR experiences an issue the AVR will shut down and send an email notification if this section is configured. After entering the configuration parameters use the 'Send Test Email' button to confirm your settings are correct.</p>
 <p>Set Password</p> <p>Enter New Password: <input type="password"/></p> <p>Re-enter Password: <input type="password"/></p> <p><input type="button" value="Save Password"/></p> <p>Copyright © 2009 Plitron Inc.</p>	<h3>Set Password</h3> <p>If you wish to change the password, use this screen.</p> <p><i>In case your forget your new password,</i> you can restore the AVR to factory default password by pressing the button on the front of the AVR unit and HOLDING it down for at least 10 seconds. The default password is avr</p>



Torus Power AVR

- AVR Status
- Switch Power
- Setup
- Email Configuration
- Set Password
- Torus Power Home
- Network Configuration**

AVR Network Configuration

This page allows the configuration of the AVR's network settings.

CAUTION: Incorrect settings may cause the AVR to lose network connectivity. Recovery options will be provided on the next page.

Enter the new settings for the AVR below:

MAC Address:	<input type="text" value="00:50:C2:B5:D1:36"/>
Host Name:	<input type="text" value="AVR"/>
	<input checked="" type="checkbox"/> Enable DHCP
IP Address:	<input type="text" value="192.168.1.100"/>
Gateway:	<input type="text" value="192.168.1.1"/>
Subnet Mask:	<input type="text" value="255.255.255.0"/>
Primary DNS:	<input type="text" value="192.168.1.1"/>
Secondary DNS:	<input type="text" value="0.0.0.0"/>
	<input type="button" value="Save Config"/>

Copyright © 2009 Filtron Inc.

Each AVR unit has a unique MAC Address which is factory assigned.

The IP address assigned to the AVR is dynamically assigned and is displayed on this screen as well as on the front panel LCD of the AVR.

The AVR can be programmed through the web browser to automatically get an IP address from the network switch or router and this is the default setting and should work on most networks. Some networks require each PC or device to use a fixed IP address and the AVR also supports this option.

Notes:

1. The output current (Amps) displayed on the LCD is the RMS reading of the load. It does not indicate the peak current loads.
2. There is a 20-second delay built into the AVR system, to prevent nuisance switching. The AVR will take approximately 20-seconds to change relay taps to switch to the proper output voltage setting.
3. North American models (15A, 20A):Torus AVR will keep the output constant within the range of 115Volts to 125Volts, with an input voltage of 90V to 130V. Between 85V to 90V, and between 130V and 135V, the regulation will be reduced.
4. North American models (20A BAL):Torus AVR will keep the output constant within the range of 115Volts to 125Volts, with an input voltage of 170V to 270V. Between 160V to 170V, and between 260V and 270V, the regulation will be reduced.
5. International models (4A, 8A and 16A):Torus AVR will keep the output constant within the range of 240 ± 10Volts, with an input voltage of 170V to 270V. Between 160V to 170V, and between 260V and 270V, the regulation will be reduced.
6. A drop in the Input voltage is normal when increasing the load on the Torus AVR. This is a result of the impedance of the power line, and is a function of the distance from the electrical panel.

Switch On Delay Feature

The Automatic Voltage Regulation (AVR) feature is designed to handle normal utility fluctuations to provide the connected equipment with an optimal voltage supply. It is common when utility power is restored after a blackout that the voltage supply is unstable for a few seconds. To further protect connected equipment your AVR is equipped with a start up delay feature. When the power switch is turned on or when the power switch is on and utility power is restored, power will not be connected to the output receptacles until the delay time has passed.



Block Diagram - AVR System

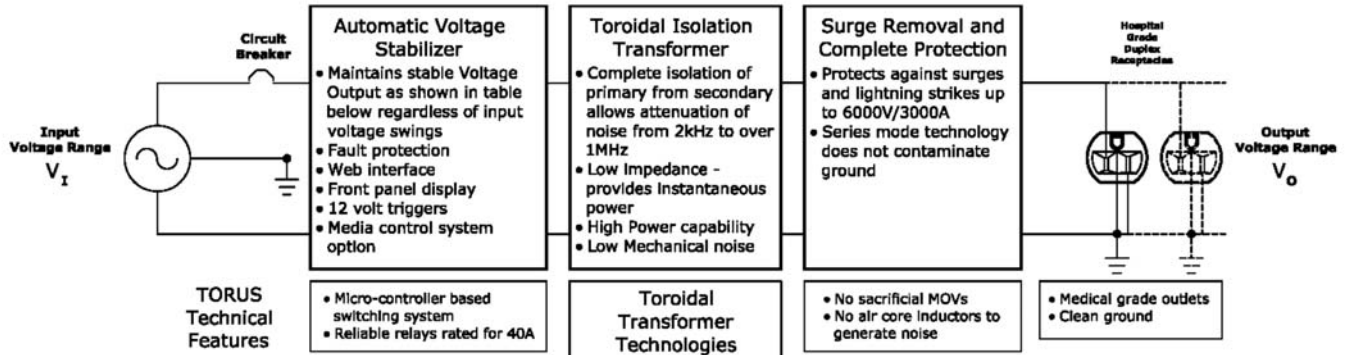

Available Models:

Model	Nominal Input	Operable Input Range	Output
North American	120V	85V-135V	120V±5V
International	220V	150V-250V	220V±10V
International	220V	160V-250V	230V±10V
International	230V	160V-260V	230V±10V
International	240V	170V-270V	240V±10V
North American Balanced	240V	170V-270V	120V±5V

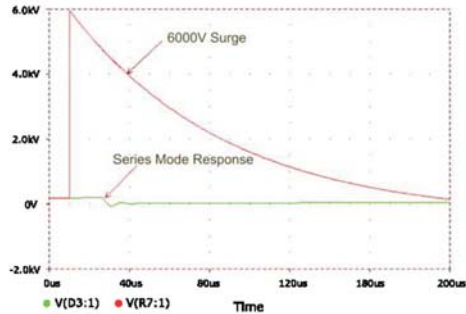
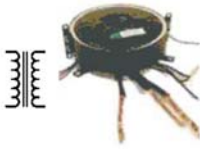

Layout

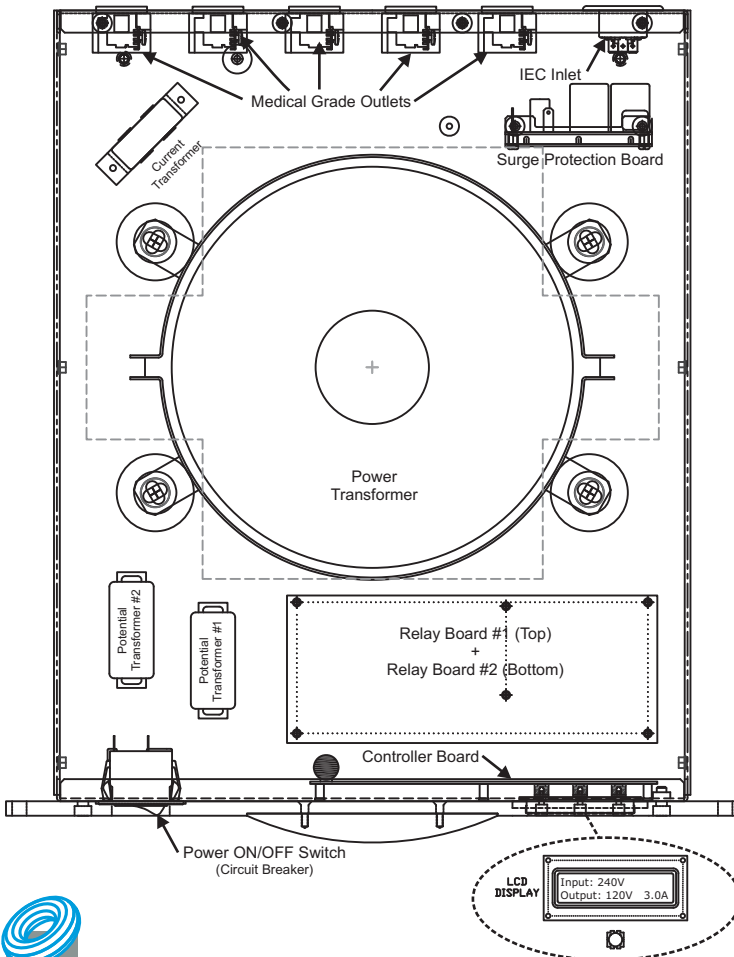

Note:
 Layout drawing is provided for reference only, Torus Power AVR units have no serviceable parts inside. Please return unit to manufacturer for repair and service when required.



Schematic North American Model

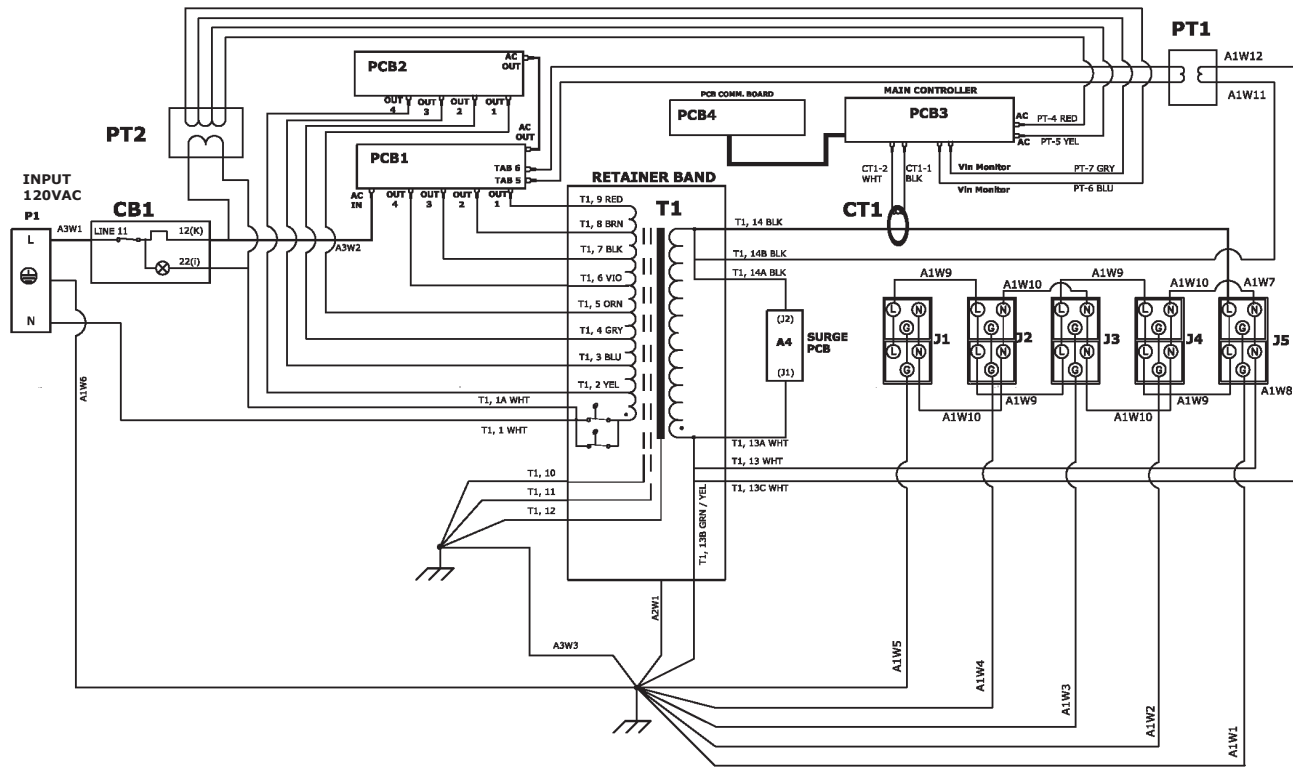

Schematic International Model

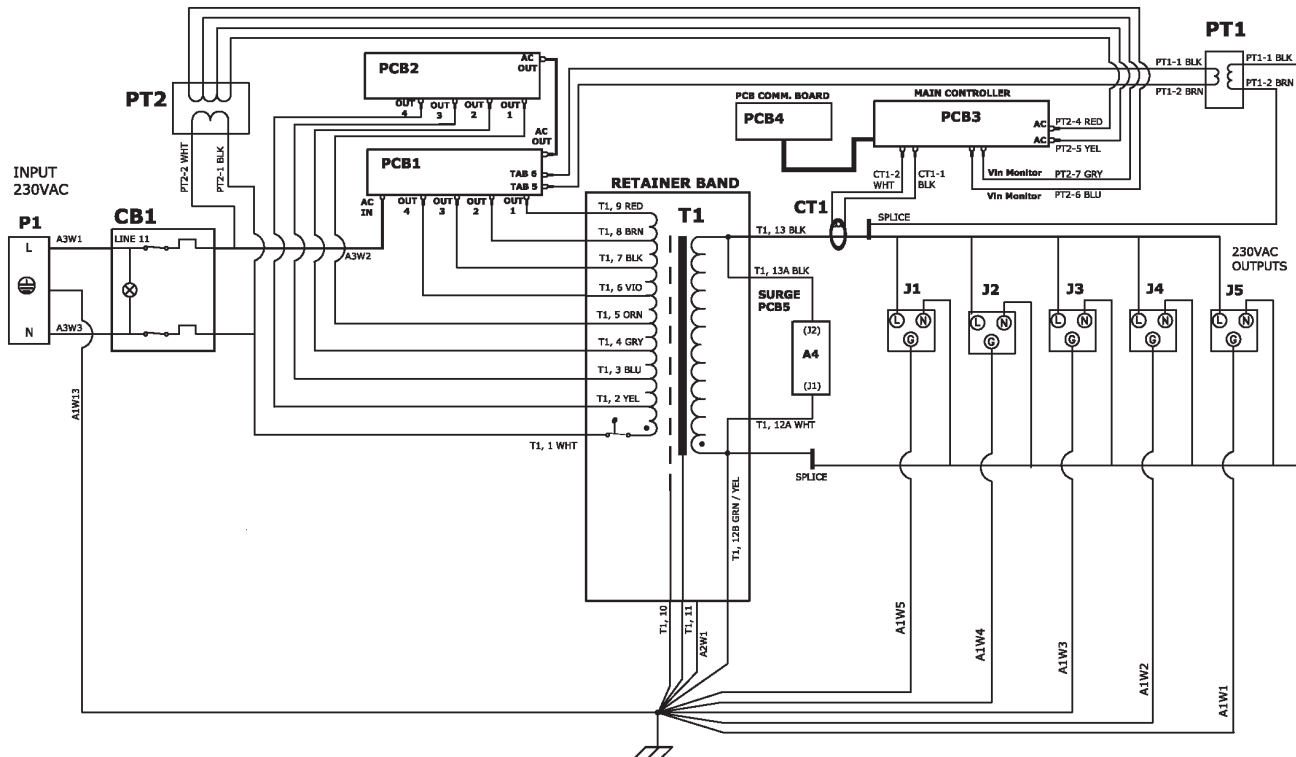

Note:
Schematic drawings are provided for reference only, Torus Power AVR units have no serviceable parts inside. Please return unit to manufacturer for repair and service when required.



North American Model Numbers

19" Pro Series Rack Mount(RM)	17" Consumer Series (CS)	Maximum Available Output Current	Input Voltage Nominal Operating Range (85-135VAC)	Output Voltage Nominal ±5V	Output Connector Medical-grade 15A
AVR 15 RK	AVR 15 CS AVR 15 CB	15A	120VAC Operating Range (85-135VAC)	120VAC ±5V	10 outlets Medical-grade 15A
AVR 20 RK	AVR 20 CS AVR 20 CB	20A	120VAC Operating Range (85-135VAC)	120VAC ±5V	10 outlets Medical-grade 20A
AVR 20 BAL RK	AVR 20 BAL CS AVR 20 BAL CB	20A	240VAC Operating Range (170-270VAC)	120VAC ±5V	10 outlets Medical-grade 20A

International Model Numbers

19" Pro Series Rack Mount(RM)	17" Consumer Series (CS)	Maximum Available Output Current	Input Voltage Nominal Operating Range (170-270VAC)	Output Voltage Nominal ±10V	Output Connector UK panel mount socket 4 outlets 16A/250V Ivory Continental European Socket 3 outlets Australian Interpower Socket 5 outlets UK panel mount socket 5 outlets 16A/250V Ivory Continental European Socket 5 outlets Australian Interpower Socket 6 outlets UK panel mount socket 8 outlets 16A/250V Ivory Continental European Socket 5 outlets Australian Interpower Socket
AVR 4 UK RK	AVR 4 UK CS AVR 4 UK CB	4A	Operating Range (170-270VAC)	220 or 230 or 240VAC ±10V	3 outlets UK panel mount socket
AVR 4 CE RK	AVR 4 CE CS AVR 4 CE CB	4A	Operating Range (170-270VAC)	220 or 230 or 240VAC ±10V	4 outlets 16A/250V Ivory Continental European Socket
AVR 4 AUS RK	AVR 4 AUS CS AVR 4 AUS CB	4A	Operating Range (170-270VAC)	220 or 230 or 240VAC ±10V	3 outlets Australian Interpower Socket
AVR 8 UK RK	AVR 8 UK CS AVR 8 UK CB	8A	Operating Range (170-270VAC)	220 or 230 or 240VAC ±10V	5 outlets UK panel mount socket
AVR 8 CE RK	AVR 8 CE CS AVR 8 CE CB	8A	Operating Range (170-270VAC)	220 or 230 or 240VAC ±10V	5 outlets 16A/250V Ivory Continental European Socket
AVR 8 AUS RK	AVR 8 AUS CS AVR 8 AUS CB	8A	Operating Range (170-270VAC)	220 or 230 or 240VAC ±10V	5 outlets Australian Interpower Socket
AVR 16 UK RK	AVR 16 UK CS AVR 16 UK CB	16A	Operating Range (170-270VAC)	220 or 230 or 240VAC ±10V	6 outlets UK panel mount socket
AVR 16 CE RK	AVR 16 CE CS AVR 16 CE CB	16A	Operating Range (170-270VAC)	220 or 230 or 240VAC ±10V	8 outlets 16A/250V Ivory Continental European Socket
AVR 16 AUS RK	AVR 16 AUS CS AVR 16 AUS CB	16A	Operating Range (170-270VAC)	220 or 230 or 240VAC ±10V	5 outlets Australian Interpower Socket

*Note: For the Nominal Output Voltages of the International models please see table at the top of page 9 under Block Diagram - AVR System.



Typical Front Panel Layout of North American and International Models

19" Pro Series Rack Mount (RK) Faceplate

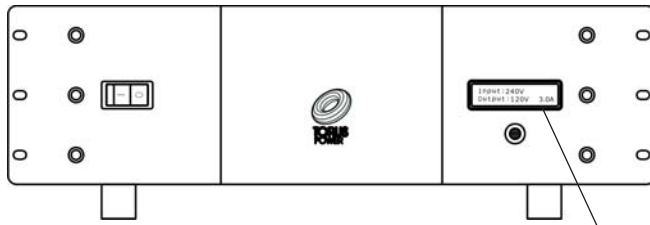

17" Consumer Series (C) Faceplate available in Black (B) and Silver (S)



Circuit Protection

The front panel power switch is also a circuit breaker. As a circuit breaker, it prevents excessive current from entering the AVR.

When the power is on, the Switch is illuminated. When the breaker trips, the switch returns to its "off" position.

Thermal Protection

Torus AVRs will shut-down if internal unit temperature reaches excessive levels.

Input Current Rating

Per UL, CSA and National Electrical codes, devices with line cords and plugs must not consume more than 80% of a branch circuit's rating.

While Torus Power AVR Units are designed to handle well beyond these limits, they must be marked with a maximum input current that satisfies the requirements.

Electrical Specifications North American Models

Model Number	Input Voltage Nominal	Input Current Limiting	Load Current Capability			Input Current Rating (see note above)
			½ cycle	1 second	10 seconds	
AVR 20 BAL RK	240VAC (2 x 120VAC, balanced)	10A Circuit Breaker	100A	80A	30A	10A
AVR 20 BAL CS	57-63Hz	Front Panel				
AVR 20 BAL CB						
AVR 20 RK	120VAC, 60Hz	20A Circuit Breaker	400A	200A	100A	16A
AVR 20 CS	57-63Hz	Front Panel				
AVR 20 CB						
AVR 15 RK		16A Circuit Breaker	300A	150A	75A	12A
AVR 15 CS		Front Panel				
AVR 15 CB						

Mechanical Specifications North American Models

Model Number	Input Connector (Rear Panel)	Line Cord (included)	Suggested Wall Receptacle	Output Connector (Rear Panel)	Weight	Size (mm) Size (inch) (w x d x h)
AVR 20 BAL RK	IEC 320-C20 Inlet	N6/15, 14AWG C19, 15A/250V	NEMA 6-15R 15A - 250V	Qty 5 (10 outlets) Medical-grade duplex 20A	45.7kg 100.5lbs	483 x 565 x 159 19 x 22.25 x 6.25
AVR 20 BAL CS					45.0kg	432 x 556 x 162
AVR 20 BAL CB					99lbs	17 x 22 x 6.4
AVR 20 RK	IEC 320-C20 Inlet	N5/20, 12AWG C19, 20A/125V	NEMA 5-20R 20A - 125V	Qty 5 (10 outlets) Medical-grade duplex 20A	45.7kg 100.5lbs	483 x 565 x 159 19 x 22.25 x 6.25
AVR 20 CS					45.0kg	432 x 556 x 162
AVR 20 CB					99lbs	17 x 22 x 6.4
AVR 15 RK	IEC 320-C14 Inlet	N5/15, 14AWG C13, 15A/125V	NEMA 5-15R 15A - 125V	Qty 5 (10 outlets) Medical-grade duplex 15A	20.9kg 46lbs	483 x 489 x 102 19 x 19.25 x 4
AVR 15 CS					20.2kg	432 x 480 x 105
AVR 15 CB					44.5lbs	17 x 18.9 x 4.13

Height includes rubber mounting feet



Line Cords and Wall Receptacles for North American Models

Standard 15A 120V

Used on: Model Number AVR 15 RK, AVR 15 CS and AVR 15 CB
Equipment end: IEC C13
Plug: 5-15P, Straight Blade, 2 pole, 3-wire grounding, 15A 125V
Cord: 3 x 14AWG
Length: 2.5 m



Standard 15A 240/208V

Used on: Model Numbers AVR 20 BAL RK, AVR 20 BAL CS and AVR 20 BAL CB
Equipment end: IEC C19
Plug: 6-15P, Straight Blade, 2 pole, 3-wire grounding, 15A 250V
Cord: 3 x 14AWG
Length: 2.5 m



Standard 20A 120V

Used on: Model Number AVR 20 RK, AVR 20 CS and AVR 20 CB
Equipment end: IEC C19
Plug: 5-20P, Straight Blade, 2 pole, 3-wire grounding, 20A 125V
Cord: 3 x 12AWG
Length: 2.5 m



Suggested Receptacles for Installation

Torus AVR's are high-power products. The outlets they are plugged into should be sufficient to provide the current to operate them without tripping circuit breakers within your junction panel.

Dedicated circuits are recommended. Balanced input products, 240VAC, require dual 120V phases (2 pole, 3-wire). Wall outlets for 240VAC are rated at 250V and will likely require special installation. Dedicated outlets, or any household or facility wiring should be installed by a licenced electrician to local codes.

Pictured below are suggested receptacle types for installation.



NEMA 6-15R for Balanced 20A unit



NEMA 5-20R for Single 20A unit



NEMA 5-15R for Single 15A unit

Rear Panel Layout of North American Models

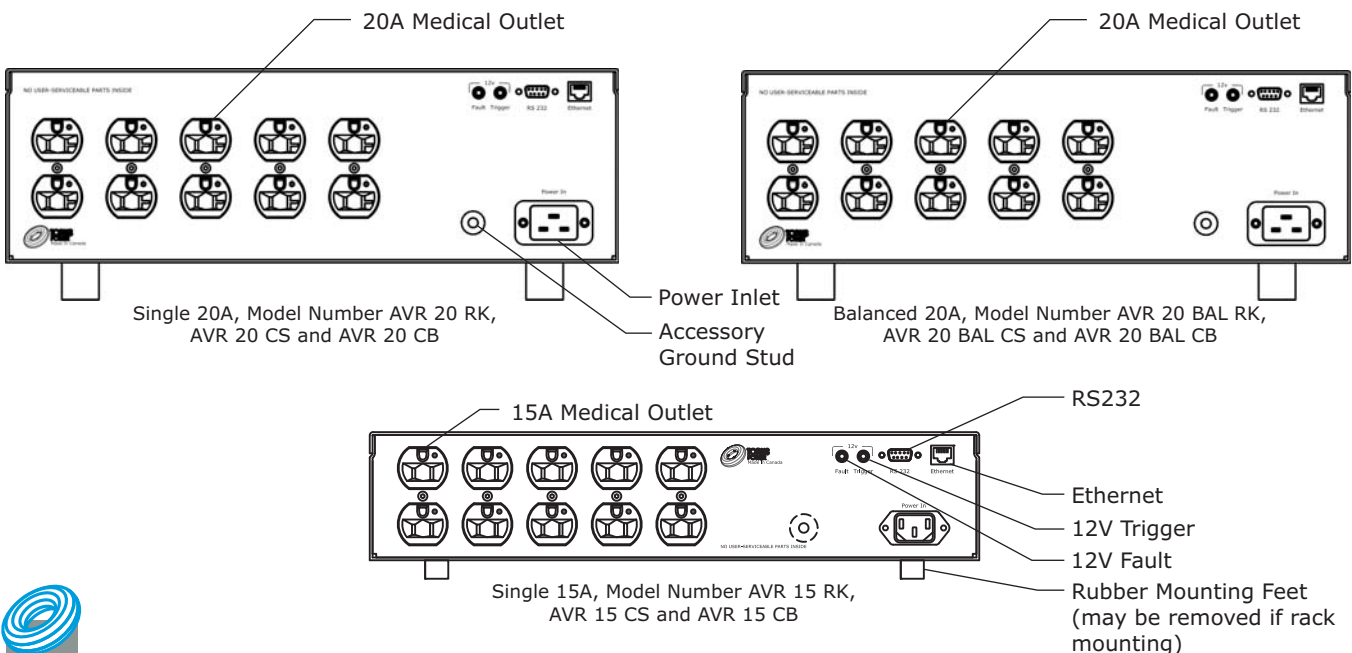

Electrical Specifications International Models

Model Number	Input Voltage Nominal	Input Current Limiting	Load Current Capability			Input Current Rating	
			½ cycle	1 second	10 seconds		
AVR 16 UK RK	Operating Range (170-270VAC) 47-53Hz	16A Circuit Breaker Front Panel	160A	96A	32A	16A	
AVR 16 UK CB			8A Circuit Breaker Front Panel	80A	46A	16A	8A
AVR 16 UK CS				4A Circuit Breaker Front Panel	80A	20A	10A
AVR 8 UK RK		16A Circuit Breaker Front Panel			160A	96A	32A
AVR 8 UK CB			8A Circuit Breaker Front Panel		80A	46A	16A
AVR 8 UK CS				4A Circuit Breaker Front Panel	80A	20A	10A
AVR 4 UK RK		16A Circuit Breaker Front Panel			160A	96A	32A
AVR 4 UK CB			8A Circuit Breaker Front Panel		80A	46A	16A
AVR 4 UK CS				4A Circuit Breaker Front Panel	80A	20A	10A
AVR 16 CE RK	Operating Range (170-270VAC) 47-53Hz	16A Circuit Breaker Front Panel			160A	96A	32A
AVR 16 CE CB			8A Circuit Breaker Front Panel		80A	46A	16A
AVR 16 CE CS				4A Circuit Breaker Front Panel	80A	20A	10A
AVR 8 CE RK		16A Circuit Breaker Front Panel			160A	96A	32A
AVR 8 CE CB			8A Circuit Breaker Front Panel		80A	46A	16A
AVR 8 CE CS				4A Circuit Breaker Front Panel	80A	20A	10A
AVR 4 CE RK		16A Circuit Breaker Front Panel			160A	96A	32A
AVR 4 CE CB			8A Circuit Breaker Front Panel		80A	46A	16A
AVR 4 CE CS				4A Circuit Breaker Front Panel	80A	20A	10A
AVR 16 AUS RK	Operating Range (170-270VAC) 47-53Hz	16A Circuit Breaker Front Panel			160A	96A	32A
AVR 16 AUS CB			8A Circuit Breaker Front Panel		80A	46A	16A
AVR 16 AUS CS				4A Circuit Breaker Front Panel	80A	20A	10A
AVR 8 AUS RK		16A Circuit Breaker Front Panel			160A	96A	32A
AVR 8 AUS CB			8A Circuit Breaker Front Panel		80A	46A	16A
AVR 8 AUS CS				4A Circuit Breaker Front Panel	80A	20A	10A
AVR 4 AUS RK		16A Circuit Breaker Front Panel			160A	96A	32A
AVR 4 AUS CB			8A Circuit Breaker Front Panel		80A	46A	16A
AVR 4 AUS CS				4A Circuit Breaker Front Panel	80A	20A	10A

Mechanical Specifications International Models

Model Number	Input (Inlet) Connector (Rear Panel)	Output Connector (Rear Panel)	Weight	Size, mm (w x d x h)
AVR 16 UK RK	IEC 320-C20	6 outlets	56 kg	483 x 662 x 203
AVR 16 UK CB		(13A/250V UK Socket)	55 kg	432 x 633 x 206
AVR 16 UK CS				
AVR 8 UK RK	IEC 320-C14	5 outlets	35 kg	483 x 565 x 159
AVR 8 UK CB		(13A/250V UK Socket)	34 kg	432 x 556 x 162
AVR 8 UK CS				
AVR 4 UK RK	IEC 320-C14	3 outlets	20 kg	483 x 489 x 102
AVR 4 UK CB		(13A/250V UK Socket)	19 kg	432 x 480 x 105
AVR 4 UK CS				
AVR 16 CE RK	IEC 320-C20	8 outlets	56 kg	483 x 662 x 203
AVR 16 CE CB		(16A/250V Ivory Continental European Socket)	55 kg	432 x 633 x 206
AVR 16 CE CS				
AVR 8 CE RK	IEC 320-C14	5 outlets	35 kg	483 x 565 x 159
AVR 8 CE CB		(16A/250V Ivory Continental European Socket)	34 kg	432 x 556 x 162
AVR 8 CE CS				
AVR 4 CE RK	IEC 320-C14	4 outlets	20 kg	483 x 489 x 102
AVR 4 CE CB		(16A/250V Ivory Continental European Socket)	19 kg	432 x 480 x 105
AVR 4 CE CS				
AVR 16 AUS RK	IEC 320-C20	5 outlets	56 kg	483 x 662 x 203
AVR 16 AUS CB		(20A/250V Interpower Socket AUS)	55 kg	432 x 633 x 206
AVR 16 AUS CS				
AVR 8 AUS RK	IEC 320-C14	5 outlets	35 kg	483 x 565 x 159
AVR 8 AUS CB		(10A/250V Interpower Socket AUS)	34 kg	432 x 556 x 162
AVR 8 AUS CS				
AVR 4 AUS RK	IEC 320-C14	3 outlets	20 kg	483 x 489 x 102
AVR 4 AUS CB		(10A/250V Interpower Socket AUS)	19 kg	432 x 480 x 105
AVR 4 AUS CS				

Height includes rubber mounting feet.



Rear Panel Layout of International Models

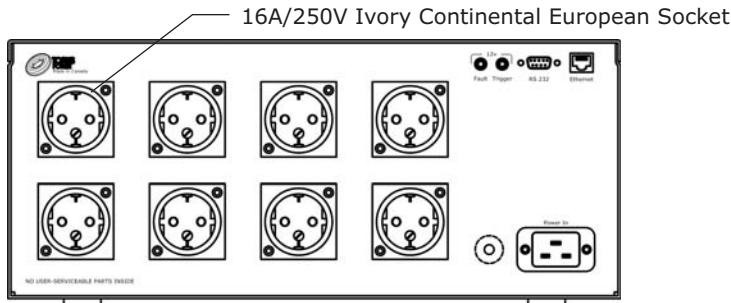

Continental Europe 16A, Model Number
AVR 16 CE RK, AVR 16 CE CS and AVR 16 CE CB

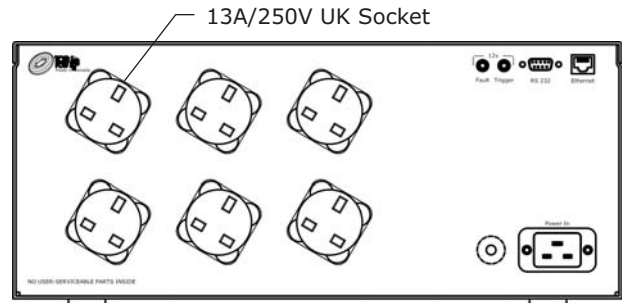

United Kingdom 16A, Model Number
AVR 16 UK RK, AVR 16 UK CS and AVR 16 UK CB

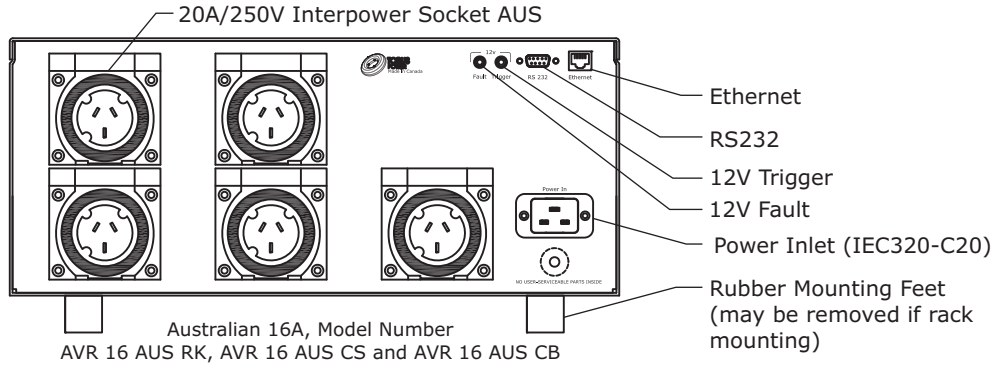

Australian 16A, Model Number
AVR 16 AUS RK, AVR 16 AUS CS and AVR 16 AUS CB

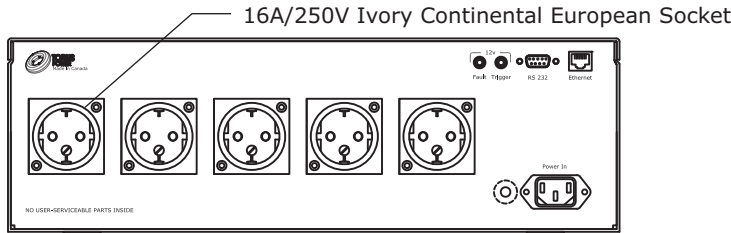

Continental Europe 8A, Model Number
AVR 8 CE RK, AVR 8 CE CS and AVR 8 CE CB

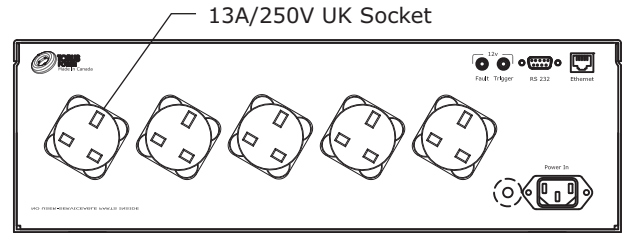

United Kingdom 8A, Model Number
AVR 8 UK RK, AVR 8 UK CS and AVR 8 UK CB

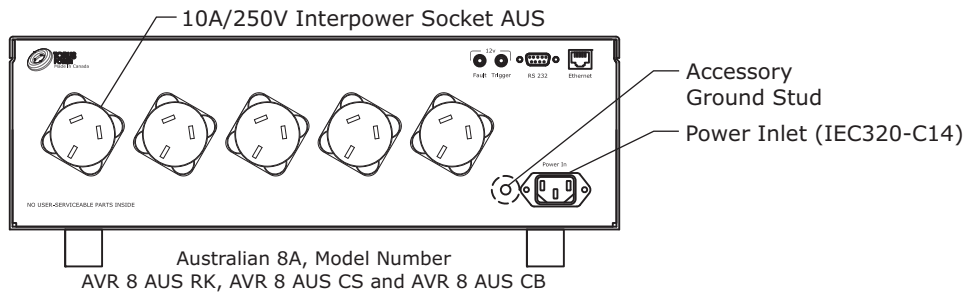

Australian 8A, Model Number
AVR 8 AUS RK, AVR 8 AUS CS and AVR 8 AUS CB

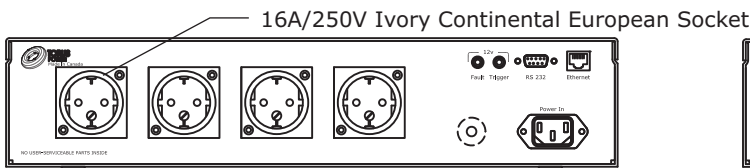

Continental Europe 4A, Model Numbers
AVR 4 CE RK, AVR 4 CE CS and AVR 4 CE CB

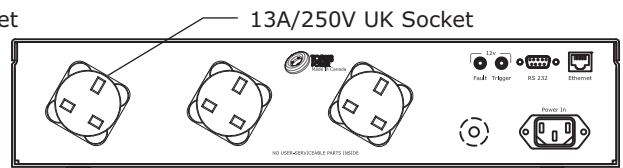

United Kingdom 4A, Model Numbers
AVR 4 UK RK, AVR 4 UK CS and AVR 4 UK CB

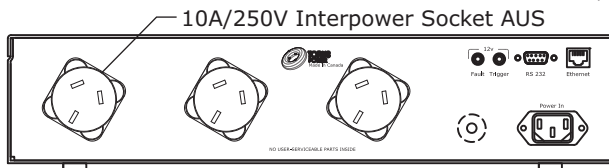

Australian 4A, Model Numbers
AVR 4 AUS RK, AVR 4 AUS CS and AVR 4 AUS CB



Home Automation Interface

Serial Port Settings

9600 baud
8 data bits
No parity

Commands are terminated with the carriage return character (13 decimal).

Command	Description	Response
"C0<CR>"	Turn off power	"OK<CR>"
"C1<CR>"	Turn on power	"OK<CR>"
Other commands	Not supported	"ERROR<CR>"

Warranty

Torus Power products are warranted to be free from manufacturing defects for five years from the original date of sale. This includes parts, labour and return shipping to the first registered owner and all subsequent registered owners. Warranty coverage is extended to applicable products registered or having proof-of-purchase (sales invoice, etc.).

failure of the product or any component part was caused by damage (not resulting from a defect or malfunction) or abuse while in the possession of the customer. Failure to fully comply with Torus Power operating instructions, voids the warranty.

In the event of a defect or malfunction, Torus Power will remedy the problem by repair or replacement, as we deem necessary, to restore the product to full performance.

This warranty is considered void if the defect, malfunction or



Torus Power products are marketed worldwide through Plitron Manufacturing Inc.

For sales contact:

torussales@plitron.com

Phone: 416-667-9914

Toll free: 1-800-754-8766

Fax: 416-667-8928

Technical inquiries:

torustechnical@plitron.com

Phone: 416-667-9914



www.TorusPower.com

Torus Power
#8 601 Magnetic Drive
Toronto, ON M3J 3J2
Canada
416-667-9914

Specifications subject to change without notice.
© Torus Power 2013