

TORUS POWER

Engineered to perform
& protect like no other

Toroidal Isolation
Power Transformers

RM Series Manual

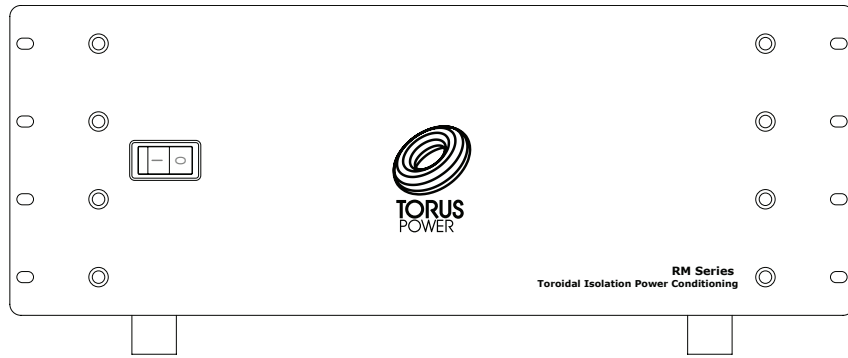

19" Pro Series Rack Mount (RK) Faceplate

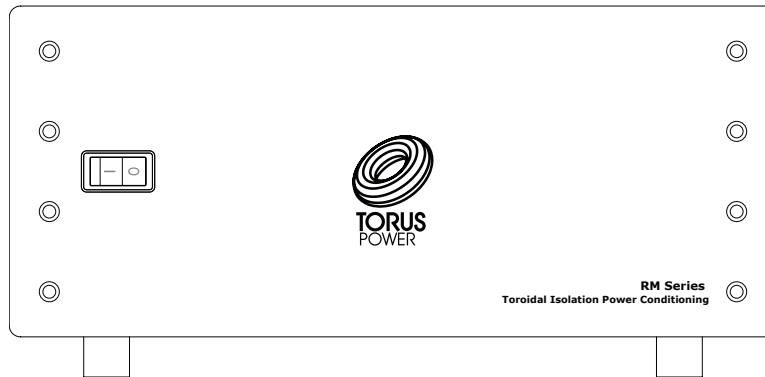

17" Consumer Series (C) Faceplate
Available in Black (B) and Silver (S) colours

Table of Contents

Table of Contents.....	Page 1
Important Safety Instructions.....	Page 2
Shipping Carton & Packing Material.....	Page 2
Placement & Ventilation.....	Page 2
Torus Power RM Series Description.....	Page 3
Power Sharing Outputs.....	Page 3
Circuit Protection.....	Page 3
Thermal Protection.....	Page 3
Circuit Schematic - North American RM Model.....	Page 4
Circuit Schematic - International RM Model.....	Page 4
Electrical Specifications - North American Models.....	Page 5
Electrical Specifications - International Models.....	Page 5,6
Mechanical Specifications - North American Models.....	Page 6
Mechanical Specifications - International Models.....	Page 6,7,8
Typical Front panel layout - North American and International Models.....	Page 8
Rear Panel Layout - North American Models.....	Page 9
Rear Panel Layout - International Models.....	Page 9,10
Warranty.....	Page 10

Important Safety Instructions

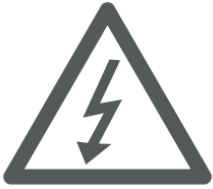

CAUTION! To reduce the risk of electric shock and fire, do not remove the cover of this device. There are no user serviceable parts inside. Please refer all servicing to licensed service technicians.

CAUTION! The international symbol of a lightning bolt inside a triangle is intended to alert the user to uninsulated "dangerous voltage" within the device's enclosure. The international symbol of an exclamation point inside a triangle is intended to alert the user to the presence of important operating, maintenance and servicing information in the manual accompanying the device.



CAUTION! To prevent electrical shock, match wide blade of plug to wide slot, fully insert.

CAUTION! To reduce the risk of electrical shock, do not expose this equipment to rain or moisture.

1. Read Instructions—All safety and operating instructions should be read before operating the device.
2. Retain Instructions—The safety and operating instructions should be retained for future reference.
3. Heed Warnings—All warnings on the device and in the operating instructions should be adhered to.
4. Follow Instructions—All operating and safety instructions should be followed.
5. Water & Moisture—The device should never be used in, on or near water for risk of fatal shock.
6. Ventilation—The device should always be located in such a way that it maintains proper ventilation. It should never be placed in a built-in installation or anywhere that may impede the flow of air through its ventilation slots.
7. Heat—Never locate the device near heat sources such as radiators, floor registers, stoves or other heat-generating devices.
8. Power Cord Protection—Power cables should be routed so they are not likely to be stepped on or crushed by items placed on them or against them. Special attention should be paid to areas where the plug enters a socket or fused strip and where the cord exits the device.
9. Periods Of Non-Use—The device should be unplugged when not being used for extended periods.
10. Dangerous Entry—Care should be taken that no foreign objects or liquids fall or are spilled inside the device.
11. Service—The device should always be serviced by licensed technicians. Only replacement parts specified by the manufacturer should be used. The use of unauthorized substitutions may result in fire, shock, or other hazards.
12. Damage Requiring Service—The device should be serviced by licensed technicians when:
 - The plug or power supply cord has been damaged.
 - Objects have fallen or liquid has spilled inside the device.
 - The device has been exposed to moisture.
 - The device does not appear to be operating properly or exhibits a marked change in performance.
 - The device has been dropped or the enclosure becomes damaged.
13. Do not position the equipment so that it is difficult to operate the disconnecting device (power cord).
14. If the equipment is used in a manner not specified by the manufacturer, the protection provided by the equipment may be impaired.
15. The power switch should be in the "off" position when connecting or disconnecting equipment from a Torus Power unit.
16. CAUTION Some units can be very heavy, please use safe practices when lifting.



≥18 kg (39.7 lb)



≥32 kg (70.5 lb)



≥55 kg (121.2 lb)

Shipping Carton & Packing Material

Please keep the original shipping box and all packing material. This will ensure the unit is protected in future transport.

In the unlikely event you have a problem and must return it for service you must use the original packing material.

Ship the unit only in the original packing material, as the unit is not insurable by carriers otherwise.

Placement & Ventilation

Torus power PIUs are extremely efficient yet very high power devices, and must be adequately cooled.

PIUs have ventilation slots on the base, side panels and on the cover. Maintain at least 1" distance from each of these surfaces to anything else. Should your installation conditions be constricted, additional forced air-cooling may be necessary.

Do not install the unit directly above heat generating equipment. Maintain at least 6" behind the PIU for adequate wiring space.

Torus Power RM Series Description

Torus Power PIUs (Power Isolation Units) combine the best surge suppression with unique toroidal transformer technologies from PLITRON to provide the ultimate performance and protection for sensitive audio and video equipment applications.

North American units are available in either single 120V input, or dual 120V (Balanced) input. Balanced input power from two 120V phases provides high input power and noise cancellation. Using balanced input power provides the benefits of symmetrical power without the requirement to use GFCI (ground fault circuit interruption) outlets. GFCIs are prone to nuisance trips. The toroidal isolation transformer steps down the 240V input to 120V to power equipment. (Where 240V balanced input is unavailable, units may be configured for 208V operation.)

PIUs use ZeroSurge patented series mode surge removal filters to absorb dangerous voltage surges and safely dissipate them without using failure prone MOVs (metal oxide varistors). Also, unlike MOV based protection, voltage surges are not shunted to ground.

Isolation is combined with proven proprietary technologies from PLITRON in the oversized toroidal transformer. NBT works as a low pass filter using the controlled leakage inductance and capacitances within the transformer to cancel common mode and differential mode noise. LoNo technology has been used for years by high end audio companies who demand silent transformers. Imin technology reduces inrush currents. UST provides additional common mode filtering using a highly efficient Faraday screen.

Low-impedance output with balanced high power primary input provides the most unconstrained, yet protected, energy source available to your equipment.

Power Sharing Outputs

The front panel Output Power Switches/Breakers are numbered to correspond with outlets on the rear panel. Each Switch/Breaker controls and protects a bank of outlets. However, all outlet banks share a single winding (output) on the isolation transformer. This "Power-Sharing" allows huge excursions of current, up to and beyond the full power of the unit, to be available at any individual outlet, for instantaneous bursts of power.

Circuit Protection

The front panel power switch is appropriately fused and hence it prevents excessive current from entering the PIU.

Thermal Protection

The Torus Power PIU will shut down if internal unit temperature reached excessive levels.

Circuit Schematic - North American RM Model (RM 20 BAL)

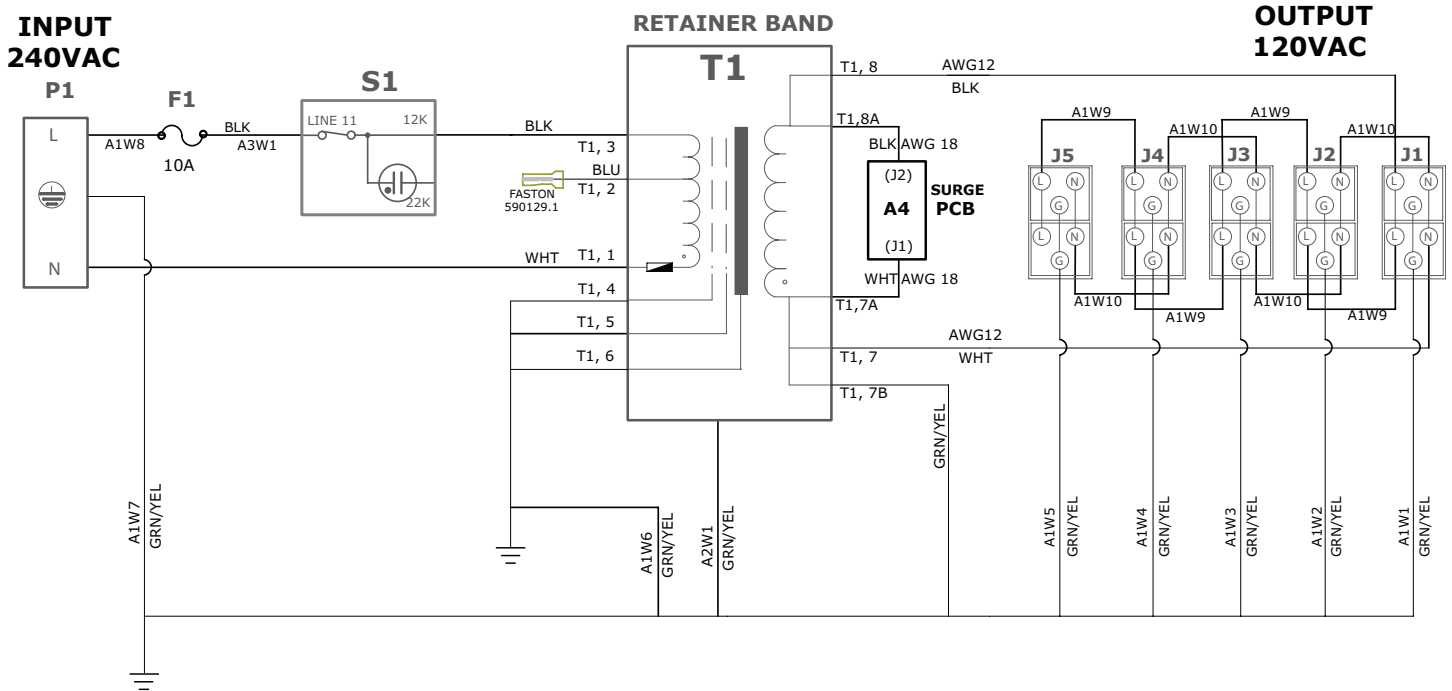

Circuit Schematic - International RM Model (RM 16 CE)

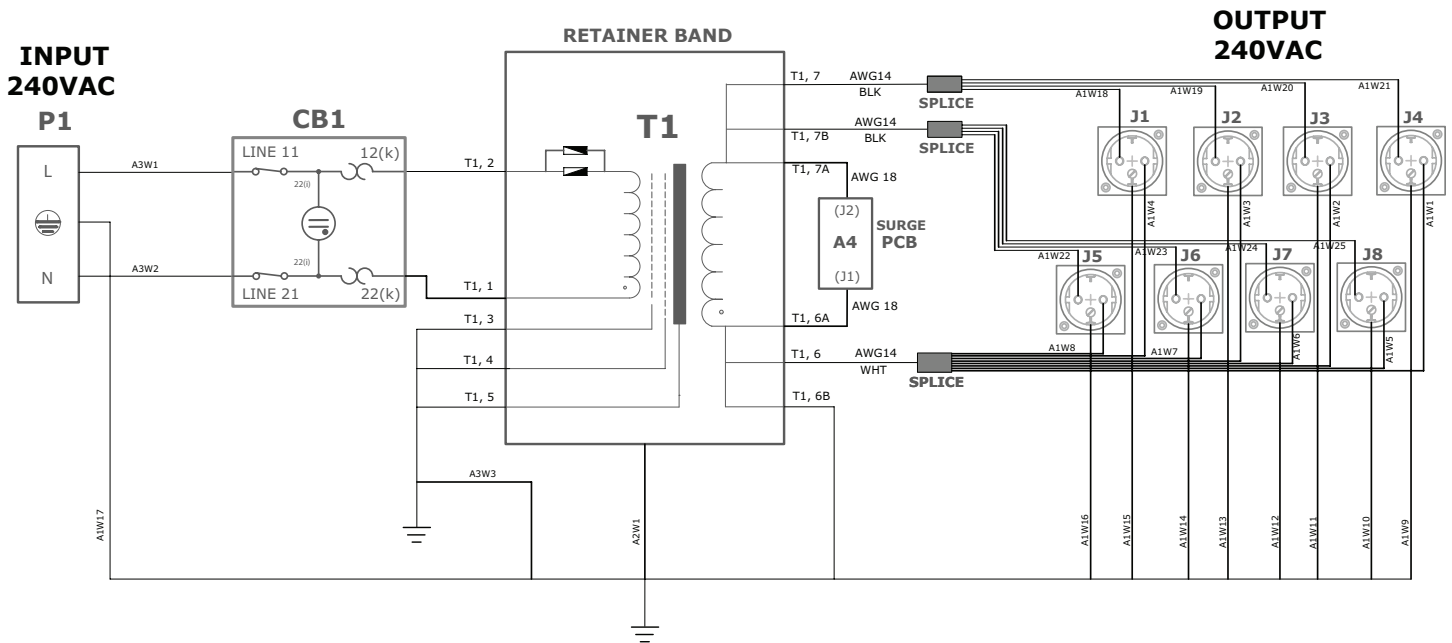

Note:

Circuit schematic drawing is provided for reference only, Torus Power RM units have no user serviceable parts inside. Please return unit to manufacturer for repair and service when required.

Electrical Specifications - North American Model

Model Number	Input Voltage Nominal	Output Voltage Nominal	Input Circuit Breaker (Fuses)	Maximum Available Output Current
RM 5	120VAC, 60Hz	120VAC	1x5A	5A
RM 10			1x10A	10A
RM 15			1x15A	15A
RM 15 PLUS			1x15A (Fuse)	15A
RM 20			1x20A (Fuse)	20A
RM 20 BAL	240VAC, 60Hz or 208VAC, 60Hz	120VAC	1x10A (Fuse)	20A
RM 45 BAL			2x25A (Fuses)	45A
RM 60 BAL			2x30A (Fuses)	60A
RM 75 BAL			2x40A (Fuses)	75A
RM 90 BAL			2x45A (Fuses)	90A

Electrical Specifications - International Model

Model Number	Input Voltage Nominal	Output Voltage Nominal	Input Circuit Breaker (Fuses)	Maximum Available Output Current
RM 4 CE	220-240VAC, 50/60Hz	220-240VAC	1x4A	4A
RM 8 CE			1x8A	8A
RM 16 CE			1x16A	16A
RM 30 CE			2x30A (Fuses)	30A
RM 45 CE			2x45A (Fuses)	45A
RM 4 UK	220-240VAC, 50/60Hz	220-240VAC	1x4A	4A
RM 8 UK			1x8A	8A
RM 16 UK			1x16A	16A
RM 30 UK			2x30A (Fuses)	30A
RM 45 UK			2x45A (Fuses)	45A
RM 4 AUS	220-240VAC, 50/60Hz	220-240VAC	1x4A	4A
RM 8 AUS			1x8A	8A
RM 16 AUS			1x16A	16A
RM 30 AUS			2x30A (Fuses)	30A
RM 45 AUS			2x45A (Fuses)	45A
RM 4 NEUTRIK	220-240VAC, 50/60Hz	220-240VAC	1x4A	4A
RM 8 NEUTRIK			1x8A	8A
RM 16 NEUTRIK			1x16A	16A
RM 30 NEUTRIK			2x30A (Fuses)	30A
RM 45 NEUTRIK			2x45A (Fuses)	45A
RM 4 IEC	220-240VAC, 50/60Hz	220-240VAC	1x4A	4A
RM 8 IEC			1x8A	8A
RM 16 IEC			1x16A	16A
RM 30 IEC			2x30A (Fuses)	30A
RM 45 IEC			2x45A (Fuses)	45A
RM 15 JP	100VAC, 50/60Hz	100VAC	15A (Fuse)	15A
RM 20 JP			20A (Fuse)	20A

Electrical Specifications - International Models (Continued)

Model Number	Input Voltage Nominal	Output Voltage Nominal	Input Circuit Breaker (Fuses)	Maximum Available Output Current
RM 4 615R	220-240VAC, 50/60Hz	220-240VAC	1x4A	4A
RM 8 615R			1x8A (Fuse)	8A
RM 16 620R			1x16A	16A
RM 30 620R			2x30A (Fuses)	30A
RM 45 620R			2x45A (Fuses)	45A

Mechanical Specifications - North American Model

Model Number	Input Connector (Rear Panel)	Output Connector (Rear Panel)	Line Cord	Size, mm (WxDxH) Size, inch (WxDxH)	Weight KG(lb)	Chassis Height
RM 5	IEC 15A Inlet, NEMA C14	6 Medical Grade Outlets, 15A	N5/15, 14AWG-C13, 15A/125V	483x287x102 19x11.3x4	13(29)	2U (3.50")
RM 10		8 Medical Grade Outlets, 15A			16(35)	
RM 15		10 Medical Grade Outlets, 15A			19.5(43)	
RM 15 PLUS	IEC 20A Inlet, NEMA C20	10 Medical Grade Outlets, 15A	N5/15, 12AWG-C19, 20A/125V	483x419x159 19x16.5x6.3	34.5(76)	3U (5.25")
RM 20		10 Medical Grade Outlets, 20A	N5/20, 12AWG-C19, 20A/125V		35.5(78)	
RM 20 BAL			N6/15, 14AWG-C19, 15A/125V		35.5(78)	
RM 45 BAL	Hubbell Twist-lock 30A/250V NEMA L6-30P	18 Medical Grade Outlets, 20A	Twist-lock, 2.5M 10AWG, 30A	483x483x203 19x19x8	58.5(129)	4U (7.00")
RM 60 BAL					70.5(155)	
RM 75 BAL	Hubbell Twist-lock 50A/250V 2P3W	24 Medical Grade Outlets, 20A	Twist-lock, 2.5M 6AWG, 50A	483x559x249 19x22x9.8	85.5(188)	5U (8.75")
RM 100 BAL					98(216)	

Mechanical Specifications - International Model

Model Number	Input Connector (Rear Panel)	Output Connector (Rear Panel)	Line Cord	Size, mm (WxDxH) Size, inch (WxDxH)	Weight KG(lb)	Chassis Height
RM 4 CE	IEC 15A Inlet, NEMA C14	16A/250V CE Socket (x4)	10A/250VAC, 2.5M Plug: CEE 7/7 Connector: IEC-C13	483x287x102 19x11.3x4	17.5(38.5)	2U (3.50")
RM 8 CE		16A/250V CE Socket (x5)			483x419x159 19x16.5x6.3	34(75)
RM 16 CE	IEC 20A Inlet, NEMA C20	16A/250V CE Socket (x8)	16A/250VAC, 2.5M Plug: CEE 7/7 Connector: IEC-C19	483x483x203 19x19x8	54(119)	4U (7.00")
RM 30 CE	Hubbell Twist-lock 30A/250V NEMA L6-30P	16A/250V CE Socket (x8)	Twist-lock, 2.5M 10AWG, 30A		78(172)	
RM 45 CE	Hubbell Twist-lock 50A/250V 2P3W	16A/250V CE Socket (x12)	Twist-lock, 2.5M 6AWG, 50A	483x559x249 19x22x9.8	98(216)	5U (8.75")

Mechanical Specifications - International Models (Continued)

Model Number	Input Connector (Rear Panel)	Output Connector (Rear Panel)	Line Cord	Size, mm (WxDxH) Size, inch (WxDxH)	Weight KG(lb)	Chassis Height
RM 4 UK	IEC 15A Inlet, NEMA C14	13A/250V UK Socket (x3)	10A/250VAC, 2.5M Plug: BS 1363 Connector: IEC-C13	483x287x102 19x11.3x4	17.5(38.5)	2U (3.50")
RM 8 UK		13A/250V UK Socket (x5)		483x419x159 19x16.5x6.3	34(75)	3U (5.25")
RM 16 UK	IEC 20A Inlet, NEMA C20	13A/250V UK Socket (x6)	13A/250VAC, 2.5M Plug: BS 1363 Connector: IEC-C19	483x483x203 19x19x8	54(119)	4U (7.00")
RM 30 UK	Hubbell Twist-lock 30A/250V NEMA L6-30P	13A/250V UK Socket (x6)	Twist-lock, 2.5M 10AWG, 30A		78(172)	
RM 45 UK	Hubbell Twist-lock 50A/250V 2P3W	13A/250V UK Socket (x8)	Twist-lock, 2.5M 6AWG, 50A	483x559x249 19x22x9.8	98(216)	5U (8.75")
RM 4 AUS	IEC 15A Inlet, NEMA C14	10A/250V AUS Socket (x3)	10A/250VAC, 2.5M Plug: AS/NZS 3112:2000 Connector: IEC-C13	483x287x102 19x11.3x4	17.5(38.5)	2U (3.50")
RM 8 AUS		10A/250V AUS Socket (x5)		483x419x159 19x16.5x6.3	34(75)	3U (5.25")
RM 16 AUS	IEC 20A Inlet, NEMA C20	20A/250V AUS Socket (x6)	13A/250VAC, 2.5M Plug: BS 1363 Connector: IEC-C19	483x483x203 19x19x8	54(119)	4U (7.00")
RM 30 AUS	Hubbell Twist-lock 30A/250V NEMA L6-30P	20A/250V AUS Socket (x6)	Twist-lock, 2.5M 10AWG, 30A		78(172)	
RM 45 AUS	Hubbell Twist-lock 50A/250V 2P3W	20A/250V AUS Socket (x8)	Twist-lock, 2.5M 6AWG, 50A	483x559x249 19x22x9.8	98(216)	5U (8.75")
RM 4 NEUTRIK	IEC 15A Inlet, NEMA C14	16A/250V NEUTRIK Socket (x4)	10A/250VAC, 2.5M	483x287x102 19x11.3x4	17.5(38.5)	2U (3.50")
RM 8 NEUTRIK		16A/250V NEUTRIK Socket (x8)	10A/250VAC, 2.5M	483x419x159 19x16.5x6.3	34(75)	3U (5.25")
RM 16 NEUTRIK	IEC 20A Inlet, NEMA C20	16A/250V NEUTRIK Socket (x12)	13A/250VAC, 2.5M	483x483x203 19x19x8	54(119)	4U (7.00")
RM 30 NEUTRIK	Hubbell Twist-lock 30A/250V NEMA L6-30P		Twist-lock 10AWG, 30A		78(172)	
RM 45 NEUTRIK	Hubbell Twist-lock 50A/250V 2P3W	16A/250V NEUTRIK Socket (x16)	Twist-lock 6AWG, 50A	483x559x249 19x22x9.8	98(216)	5U (8.75")
RM 4 IEC	IEC 15A Inlet, NEMA C14	10A/250V IEC Socket (x6)	10A/250VAC, 2.5M	483x287x102 19x11.3x4	17.5(38.5)	2U (3.50")
RM 8 IEC		10A/250V IEC Socket (x8)	10A/250VAC, 2.5M	483x419x159 19x16.5x6.3	34(75)	3U (5.25")
RM 16 IEC	IEC 20A Inlet, NEMA C20	10A/250V IEC Socket (x8) 16A/250V IEC Socket (x4)	13A/250VAC, 2.5M	483x483x203 19x19x8	54(119)	4U (7.00")
RM 30 IEC	Hubbell Twist-lock 30A/250V NEMA L6-30P		Twist-lock, 2.5M 10AWG, 30A		78(172)	
RM 45 IEC	Hubbell Twist-lock 50A/250V 2P3W		Twist-lock, 2.5M 6AWG, 50A	483x559x249 19x22x9.8	98(216)	5U (8.75")

Mechanical Specifications - International Models (Continued)

Model Number	Input Connector (Rear Panel)	Output Connector (Rear Panel)	Line Cord	Size, mm (WxDxH) Size, inch (WxDxH)	Weight KG(lb)	Chassis Height
RM 4 615R	IEC 15A Inlet, NEMA C14	8 Medical Grade Outlets, 15A	N5/15, 14AWG-C13, 2.5M	483x287x102 19x11.3x4	17.5(38.5)	2U (3.50")
RM 8 615R	IEC 20A Inlet, NEMA C20	10 Medical Grade Outlets, 15A	N5/15, 12AWG-C19, 2.5M	483x419x159 19x16.5x6.3	34(75)	3U (5.25")
RM 16 620R	IEC 20A Inlet, NEMA C20	12 Medical Grade Outlets, 20A	N5/20, 12AWG-C19, 2.5M	483x483x203 19x19x8	54(119)	4U (7.00")
RM 30 620R	Hubbell Twist-lock 30A/250V NEMA L6-30P	18 Medical Grade Outlets, 20A	Twist-lock, 2.5M 10AWG, 30A		78(172)	
RM 45 620R	Hubbell Twist-lock 50A/250V 2P3W	24 Medical Grade Outlets, 20A	Twist-lock, 2.5M 6AWG, 50A	483x559x249 19x22x9.8	98(216)	5U (8.75")
RM 15 JP	IEC 15A Inlet, NEMA C14	10 Medical Grade Outlets, 15A	N5/15, 14AWG-C13, 15A/125V	483x287x102 19x11.3x4	19.5(43)	2U (3.50")
RM 20 JP	IEC 20A Inlet, NEMA C20	10 Medical Grade Outlets, 20A	N5/20, 12AWG-C19, 20A/125V	483x419x159 19x16.5x6.3	35.5(78)	3U (5.25")

Typical Front Panel Layout - North American and International Models

19" Pro Series Rack Mount (RK) Faceplate

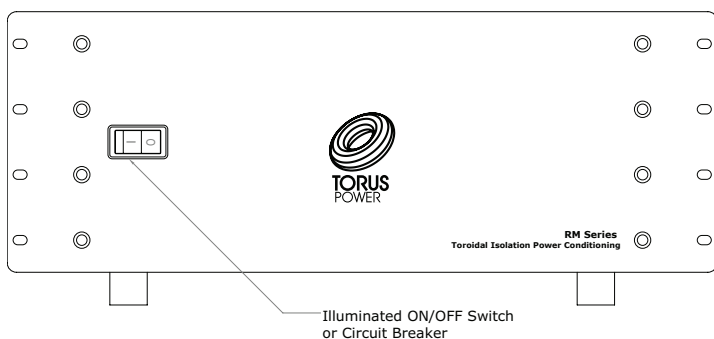

17" Consumer Series (C) Faceplate available in Black (B) and Silver (S)

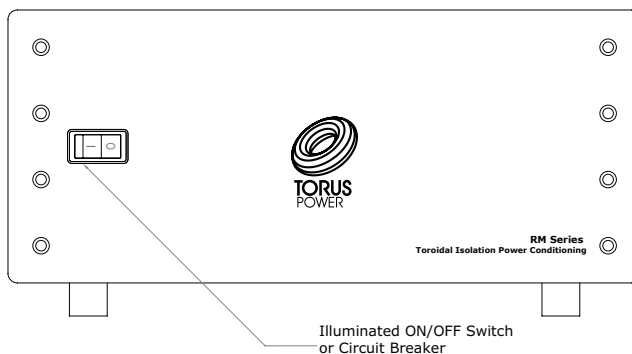

Rear Panel Layout - North American Models

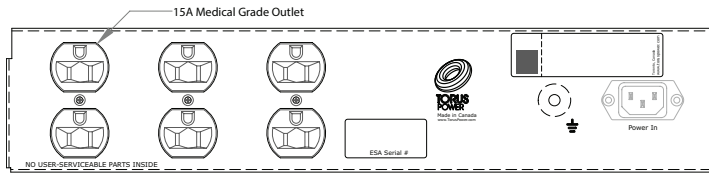

Models: RM 5 RK, RM 5 CB, RM 5 CS

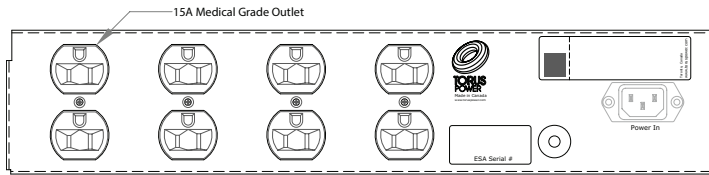

Models: RM 10 RK, RM 10 CB, RM 10 CS, RM 4 615R RK, RM 4 615R CB, RM 4 615R CS

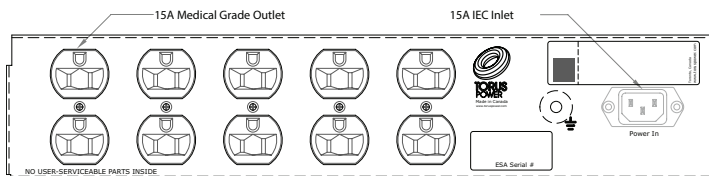

Models: RM 15 RK, RM 15 CB, RM 15 CS

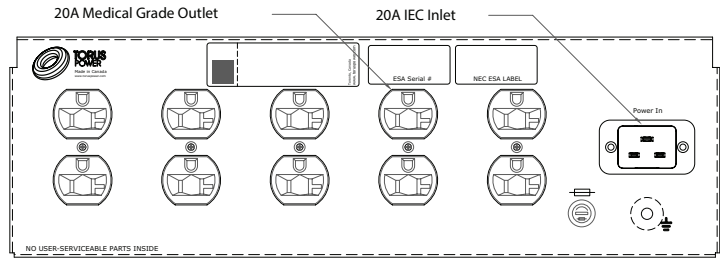

Models: RM 20 RK, RM 20 CB, RM 20 CS, RM 15 PLUS RK, RM 15 PLUS CB, RM 15 PLUS CS
Balanced Models: RM 20 BAL RK, RM 20 BAL CB, RM 20 BAL CS

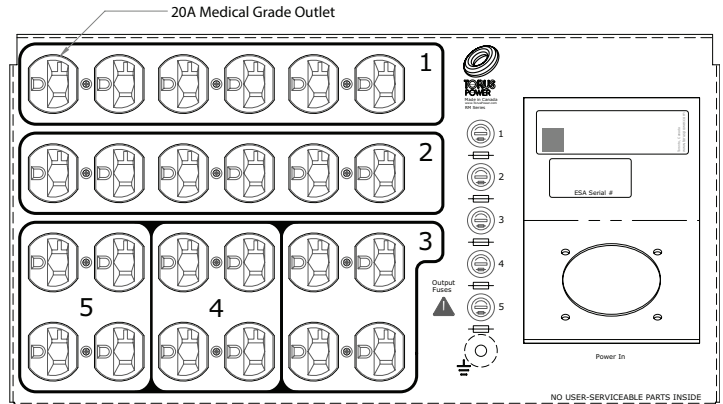

Balanced Models: RM 75 BAL RK, RM 75 BAL CB, RM 75 BAL CS, RM 100 BAL RK, RM 100 BAL CS, RM 100 BAL CB

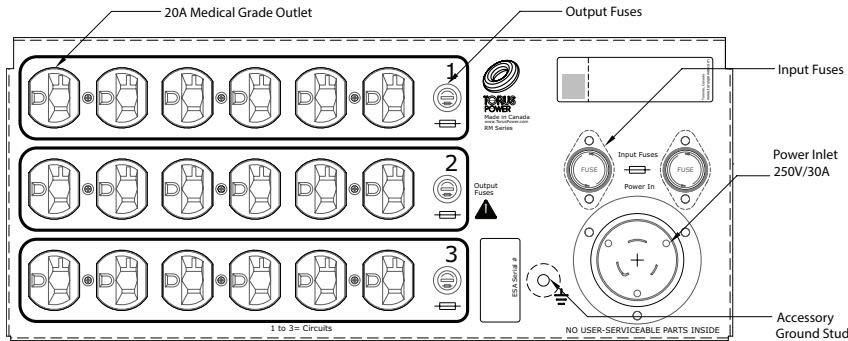

Balanced Models: RM 45 BAL RK, RM 45 BAL CB, RM 45 BAL CS, RM 60 BAL RK, RM 60 BAL CS, RM 60 BAL CB

Rear Panel Layout - International Models

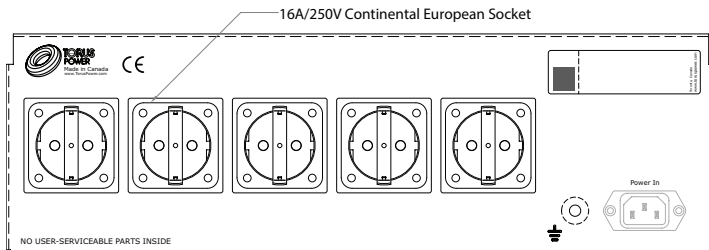

Models: RM 8 CE RK, RM 8 CE CB, RM 8 CE CS

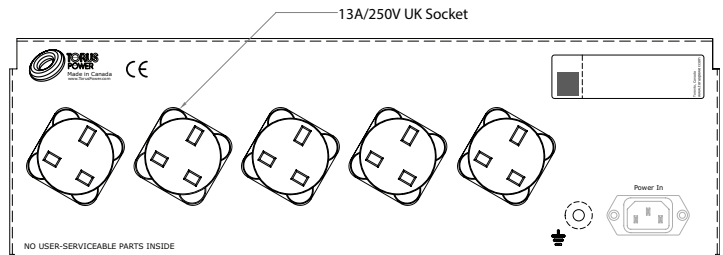

Models: RM 8 UK RK, RM 8 UK CB, RM 8 UK CS

Rear Panel Layout - International Models (Continued)

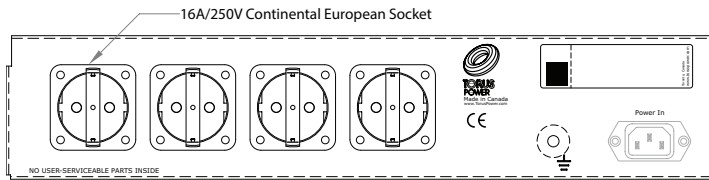

Models: RM 4 CE RK, RM 4 CE CB, RM 4 CE CS

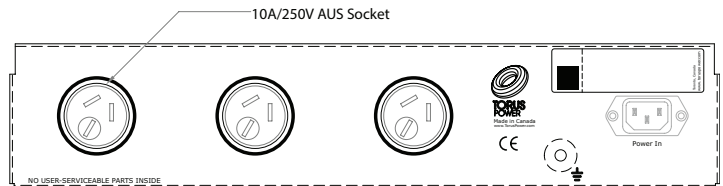

Models: RM 4 AUS RK, RM 4 AUS CB, RM 4 AUS CS

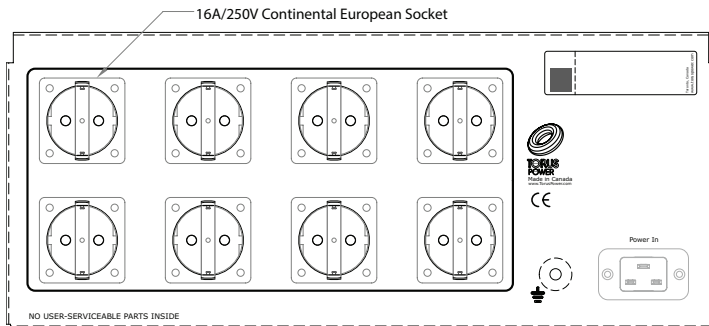

Models: RM 16 CE RK, RM 16 CE CB, RM 16 CE CS, RM 30 CE RK, RM 30 CE CB, RM 30 CE CS

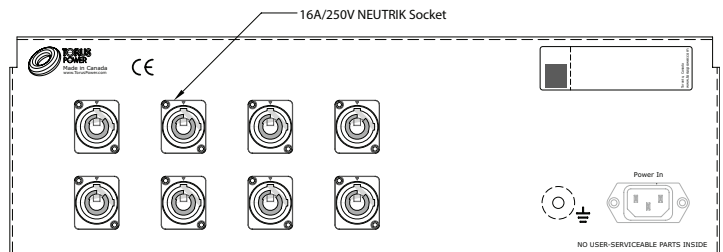

Models: RM 8 NEUTRIK RK, RM 8 NEUTRIK CB, RM 8 NEUTRIK CS

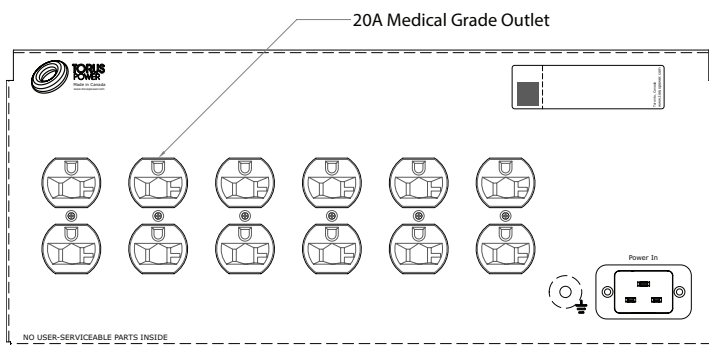

Models: RM 16 620R RK, RM 16 620R CB, RM 16 620R CS

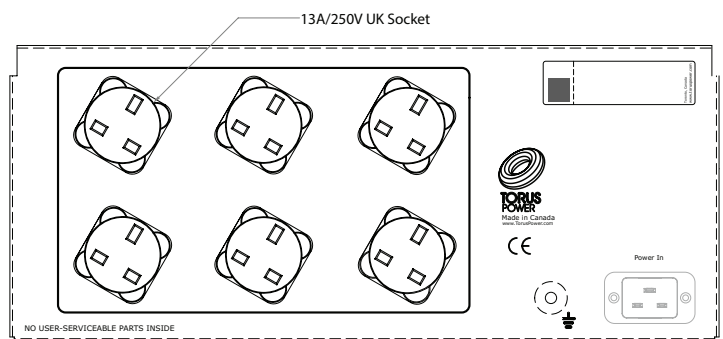

Models: RM 16 UK RK, RM 16 UK CB, RM 16 UK CS

Warranty

Torus Power Inc. products are warranted to be free from manufacturing defects as follows:

- Five years from the original date of sale for toroidal transformers
- Two years from the original date of sale for all other components

The product warranty includes parts, labour and return shipping to the customer. Shipping to Torus Power Inc. for warranty repair is the responsibility of the customer.

Warranty coverage is not transferrable and original proof of purchase is required for warranty claims.

In the event of a warranty claim, Torus Power Inc. will remedy the issue by repair or replacement, as we deem necessary, to restore the product to full performance.

This warranty is considered void if the failure of the product or any component part is caused by damage or misuse.

Failure to fully comply with Torus Power operating instructions voids the warranty.

Torus Power products are marketed worldwide by Torus Power Inc.

For sales contact:

sales@toruspower.com

Phone: (+1) 416-477-4799

Toll free: 1-877-337-9480

Technical inquiries:

tech@toruspower.com

Phone: (+1) 416-477-4799

Toll free: 1-877-337-9480



TORUS POWER

Engineered to perform
& protect like no other

**Toroidal Isolation
Power Transformers**

Torus Power Inc.

2861 Sherwood Heights Drive

Suite 26

Oakville, ON L6J 7K1

www.toruspower.com