



# TORUS POWER

Engineered to perform  
& protect like no other

Toroidal Isolation  
Power Transformers

## AVR Series Manual

**Toroidal Isolation Power Conditioning  
Automatic Voltage Regulation  
Surge Protection**

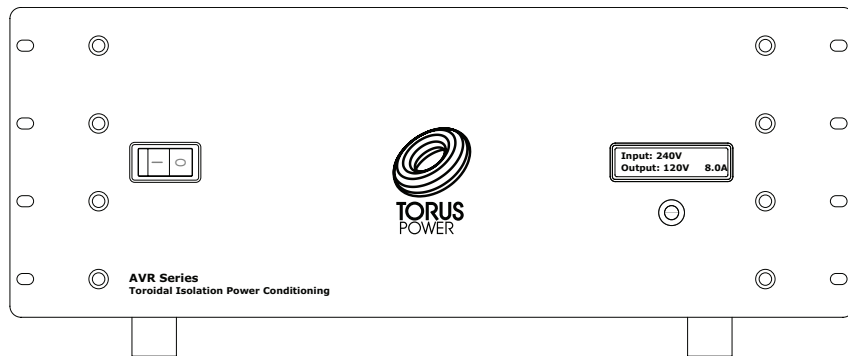

19" Pro Series Rack Mount (RK) Faceplate

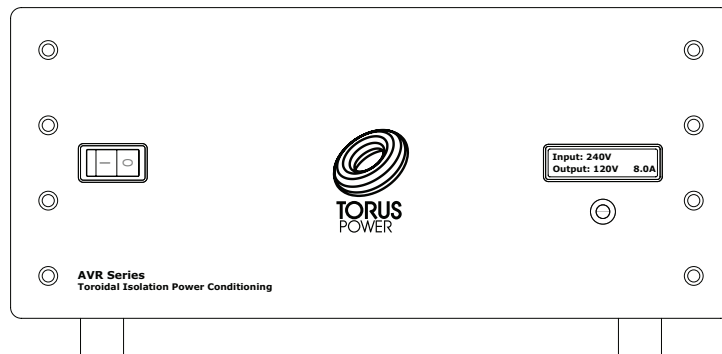

17" Consumer Series (C) Faceplate  
Available in Black (B) and Silver (S) colours



## Table of Contents

---

Table of Contents.....	Page 1
Important Safety Instructions.....	Page 2
Shipping Carton & Packing Material.....	Page 2
Placement and Ventilation.....	Page 2
Torus Power AVR Description.....	Page 3
Front Panel Display.....	Page 4
Rear Panel Connections and AVR Software.....	Page 5
AVR Software - Menu Selection.....	Page 6,7,8
Block Diagram - AVR System.....	Page 9
Layout.....	Page 9
Circuit Schematic - North American Model.....	Page 10
Circuit Schematic - International Model.....	Page 10
Electrical Specifications - North American Models.....	Page 11
Electrical Specifications - International Models.....	Page 11,12
Mechanical Specifications - North American Models.....	Page 12
Mechanical Specifications - International Models.....	Page 12,13,14
Circuit Protection.....	Page 14
Thermal Protection.....	Page 14
Front Panel Layout.....	Page 14
Rear Panel Layout - North American Models.....	Page 15
Rear Panel Layout - International Models.....	Page 16
Home Automation Interface.....	Page 17
Warranty.....	Page 17

## Important Safety Instructions

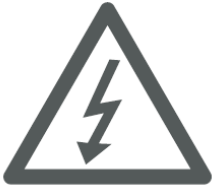

**CAUTION!** To reduce the risk of electric shock and fire, do not remove the cover of this device. There are no user serviceable parts inside. Please refer all servicing to licensed service technicians.

**CAUTION!** The international symbol of a lightning bolt inside a triangle is intended to alert the user to uninsulated "dangerous voltage" within the device's enclosure. The international symbol of an exclamation point inside a triangle is intended to alert the user to the presence of important operating, maintenance and servicing information in the manual accompanying the device.



**CAUTION!** To prevent electrical shock, match wide blade of plug to wide slot, fully insert.

**CAUTION!** To reduce the risk of electrical shock, do not expose this equipment to rain or moisture.

1. Read Instructions—All safety and operating instructions should be read before operating the device.
2. Retain Instructions—The safety and operating instructions should be retained for future reference.
3. Heed Warnings—All warnings on the device and in the operating instructions should be adhered to.
4. Follow Instructions—All operating and safety instructions should be followed.
5. Water & Moisture—The device should never be used in, on or near water for risk of fatal shock.
6. Ventilation—The device should always be located in such a way that it maintains proper ventilation. It should never be placed in a built-in installation or anywhere that may impede the flow of air through its ventilation slots.
7. Heat—Never locate the device near heat sources such as radiators, floor registers, stoves or other heat-generating devices.
8. Power Cord Protection—Power cables should be routed so they are not likely to be stepped on or crushed by items placed on them or against them. Special attention should be paid to areas where the plug enters a socket or fused strip and where the cord exits the device.
9. Periods Of Non-Use—The device should be unplugged when not being used for extended periods.
10. Dangerous Entry—Care should be taken that no foreign objects or liquids fall or are spilled inside the device.
11. Service—The device should always be serviced by licensed technicians. Only replacement parts specified by the manufacturer should be used. The use of unauthorized substitutions may result in fire, shock, or other hazards.
12. Damage Requiring Service—The device should be serviced by licensed technicians when:
  - The plug or power supply cord has been damaged.
  - Objects have fallen or liquid has spilled inside the device.
  - The device has been exposed to moisture.
  - The device does not appear to be operating properly or exhibits a marked change in performance.
  - The device has been dropped or the enclosure becomes damaged.
13. Do not position the equipment so that it is difficult to operate the disconnecting device (power cord).
14. If the equipment is used in a manner not specified by the manufacturer, the protection provided by the equipment may be impaired.
15. The power switch should be in the "off" position when connecting or disconnecting equipment from a Torus Power unit.
16. CAUTION Some units can be very heavy, please use safe practices when lifting.



≥18 kg (39.7 lb)



≥32 kg (70.5 lb)



≥55 kg (121.2 lb)

## Shipping Carton & Packing Material

Please keep the original shipping box and all packing material. This will ensure the unit is protected in future transport.

In the unlikely event you have a problem and must return it for service you must use the original packing material.

Ship the unit only in the original packing material, as the unit is not insurable by carriers otherwise.

## Placement & Ventilation

Torus power PIUs (Power Isolation Units) are extremely efficient yet very high power devices, and must be adequately cooled.

PIUs have ventilation slots on the base, side panels and on the cover. Maintain at least 1" distance from each of these surfaces to anything else. Should your installation conditions be constricted, additional forced air-cooling may be necessary.

Do not install the unit directly above heat generating equipment. Maintain at least 6" behind the PIU for adequate wiring space.

## Torus Power AVR Description

---

### Torus AVR – Description

The Torus Power AVR (Automatic Voltage Regulation) is a full-feature state-of-the-art power transformer, isolating and protecting your system. Like all Torus Power products, the AVR series provides true isolation (using massive toroidal transformers) and protects all connected equipment from the risk of severe power line surges using series-mode surge suppression. In addition, Torus AVR provides stable voltage to keep equipment running in the optimal range of 115VAC to 125VAC for any input voltage from 90V to 130VAC. (International units operate within nominal input voltage such as 220V, 230V, 240V; Torus AVR keeps them operating within a range of +/- 10V.) See table on Page 9 for more details.

The Torus Power AVR series uses a micro-processor to monitor and control the power provided to connected components. The front panel display on the Torus Power AVR indicates input and output voltages, and displays output current, as well as displaying fault conditions.

The Torus Power AVR is pre-programmed to power down the system when a high or low fault conditions occurs (user can over-ride).

There are multiple interfaces built into the Torus Power AVR:

- 1) Ethernet interface with built-in web server allows any computer to view voltage and current readings and turn the AVR unit ON or OFF.
- 2) RS-232 is provided for connection to media control systems.
- 3) Two 12VDC triggers are provided.

### Connecting components and using the AVR

Using the AVR is as simple as plugging in audio and video components to the outlets on the rear panel. The order and position in which you connect your components will not affect the performance of the AVR or your components. Connect the AVR to the wall outlet, and switch it on. Turn on the components individually.

While the AVR has built-in software that can be accessed via the Ethernet connection, there is no need for you to use this software. The AVR system provides all the standard features, performance, and benefits out - of - the - box by simply plugging it in as described in this section. You can use the AVR software to monitor the voltage conditions via your computer, and for such additional features as being able to turn your system on/off remotely and change the duration of the display's backlight.

### Does your system need automatic voltage regulation?

Under ideal conditions, when the supplied power line is stable and dependable, you may not need voltage regulation. In such an ideal situation, your equipment can operate within the normal tolerance of the line voltage.

In reality, the power supplied to most areas is less than ideal due to outdated power grids. In most areas, the power regularly drops or rises beyond the acceptable range (in North America +/- 5V, Europe/Asia/Australia +/- 10V) . These voltage sags, brownouts, and surges can stress components and shorten equipment life. In the worst case, catastrophic events can destroy valuable equipment. In such real-world conditions, the Torus Power AVR can protect your equipment, and improve the quality and enjoyment of your audio and video experience.

## Front Panel Display

---

### Front Panel

The front panel display consists of a 2 line LCD and 1 push button.

#### Typical Display

In: 115V  
Out: 120V 5.2A

Press button to show IP address (if Internet connection is used).

IP Address  
10.1.1.112

See section on AVR software for further information on the IP address.

### Voltage Faults

If a high or low voltage condition exists for 30 seconds or more, a voltage fault is displayed and the system shuts down (unless over-ridden by the user).

#### Display will Show

System OFF  
LOW AC VOLTAGE

or

System OFF  
HIGH AC VOLTAGE

As the output power from the Torus Power AVR is shut down, all the connected components are turned off. The AVR power switch remains in the ON position, although there is no power to the load.

The connected equipment should be switched off.

When the voltage has been restored to the normal operating range, the following procedure can be followed:

- The Torus Power AVR can be switched OFF and then ON.
- Wait thirty seconds to verify the fault condition no longer exists.
- The connected equipment should be switched ON individually.

If the fault condition still exists, the AVR will require approximately 15 seconds to monitor the incoming voltage, and the system will shut down again.

The user can program the AVR software to allow the system to remain ON, in case of fault (see AVR software section for details).

## Rear Panel Connections and AVR Software

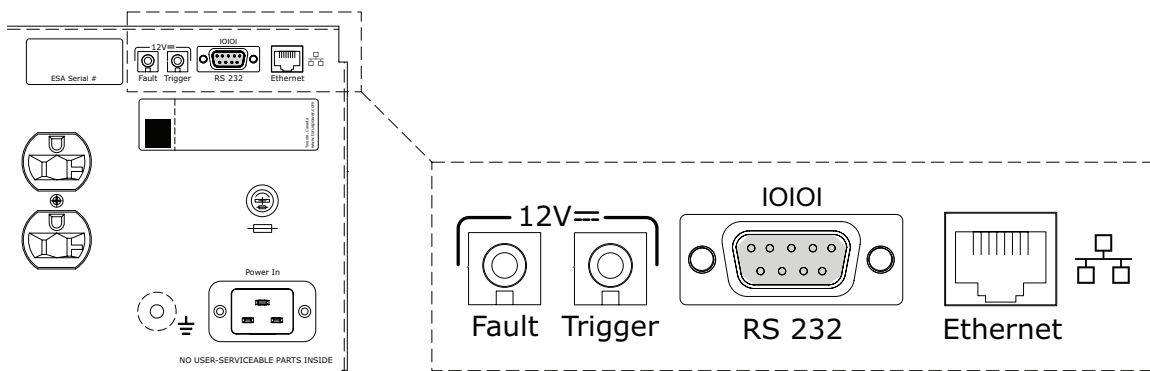

Figure 1: AVR Rear Panel Connections

### Ethernet

Allows access to the AVR and internal software. See AVR software section for more details.

### RS232

Allows access to automation and external control. See Home Automation Interface commands at end of manual.

### 12VDC Trigger On/Off

The AVR can be turned on and off by a 12 volt trigger input. Applying 12 volts turns on the AVR and removing the 12 volts turns it off.

### 12VDC Fault Output

The AVR provides a 12 volt fault output through a jack on the back panel. The output goes to 12 volts when a relay or voltage fault is detected. The maximum current that can be drawn from this output is 75mA.

### AVR Software

AVR software is resident in the microprocessor on the internal control board. There are two methods to access the software.

1) Connect the AVR to the Ethernet port. Open a browser window on a PC that is connected to the same network through another Ethernet port. Enter AVR (or the IP address displayed on the LCD) into the browser window. Press ENTER and the software will open.

2) Use a three way hub, which is connected to an existing network. You then connect both PC and AVR to the same Hub. Open a browser window from the PC. Type AVR, (or the IP address displayed on the LCD) into the browser window. Press ENTER and the software will open.

### Username and Password

The password is required to change the setup of the Torus unit.

Username is **admin** This is factory set and cannot be changed.

Password is **avr** This is the default password, and can be changed.

**In case you forget your password**, the AVR can be restored to the factory default password **avr** by pressing and holding the button on the front panel for at least 10 seconds.

## AVR Software - Menu Selections

### AVR Menu Selections

- AVR Status
- Switch Power
- Setup
- Email Configuration
- Set Password
- Torus Power Home (website)
- Network Configuration

### Screen by screen description of software options

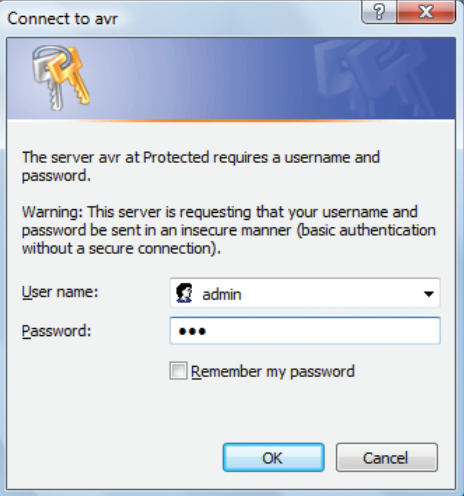
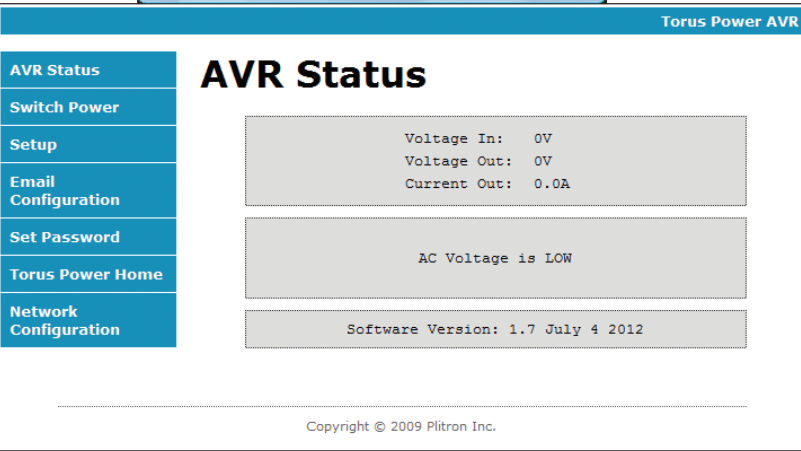
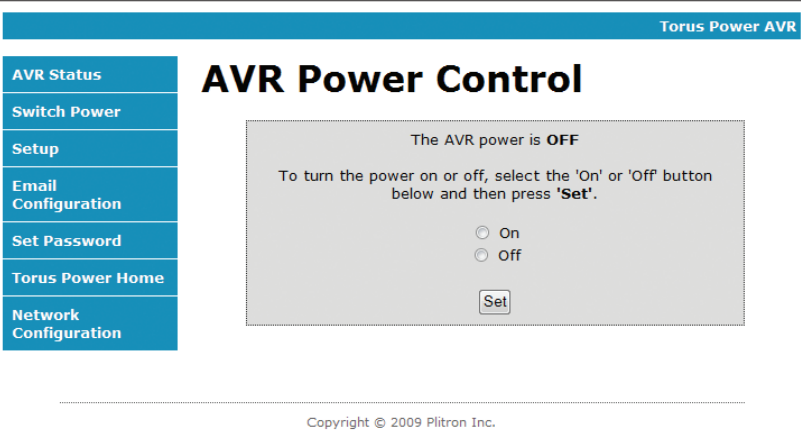
	<p>To access AVR software, enter user name and password.</p> <p>User name: <b>admin</b></p> <p>is factory set and cannot be changed.</p> <p>Default password: <b>avr</b></p> <p>You can change your password.</p> <p>Select: <b>Set Password</b></p>
	<p><b>AVR Status</b></p> <p>This screen indicates the overall status of the system, showing Voltage In, Voltage Out, and Current Out.</p> <p>It also reports if the system is functioning normally or whether there is a fault condition.</p>
	<p><b>AVR Power Control</b></p> <p>This screen allows ON or OFF control of the AVR unit.</p> <p>Press <b>SET</b> button to implement your selection.</p>



## AVR Software - Menu Selections (continued)

The screenshot shows the 'AVR Setup' page of the Torus Power AVR software. On the left is a navigation menu with options: AVR Status, Switch Power, Setup, Email Configuration, Set Password, Torus Power Home, and Network Configuration. The main content area is titled 'AVR Setup' and includes a sub-header 'Torus Power AVR'. Below the title is a description: 'This page allows the configuration of the AVR's programmable parameters.' The configuration area contains two checked checkboxes: 'Shutdown on Low or High line voltage' and 'LCD Backlight Always On'. Below these is a text input field for 'LCD Backlight Time' with the value '255' and a note '(0 to 255 seconds)'. A 'Save Setup' button is located at the bottom of the configuration area. At the bottom of the page, there is a copyright notice: 'Copyright © 2009 Plitron Inc.'

### AVR Setup

This screen allows the user to configure two AVR parameters.

#### 1. Shutdown on Low or High line voltage

The factory default is YES to shut down in case of fault conditions. Unselecting this button will override, and the AVR will remain ON even if voltage drops or rises beyond the acceptable range.

#### 2. LCD Display.

Always ON is the default setting. If you don't want the display on all the time, you can select a time from 0 to 255 seconds. When you have made your selections, press SAVE SETUP.

The screenshot shows the 'Email Configuration' page of the Torus Power AVR software. The navigation menu on the left is the same as in the previous screenshot, with 'Email Configuration' highlighted. The main content area is titled 'Email Configuration' and includes a sub-header 'Torus Power AVR'. Below the title are two numbered instructions: '1. Please enter the "Email Address" that the logged data should be sent to.' and '2. If you have multiple AVR devices, assign different "Email Subjects" to them to tell apart the logs of different devices.' The configuration area contains fields for 'SMTP Server', 'Port' (set to 25), 'User Name', and 'Password'. Below these are fields for 'Email Address' and 'Email Subject', with a 'Set' button next to the latter. A 'Send Test Email' button is located at the bottom of the configuration area. At the bottom of the page, there is a copyright notice: 'Copyright © 2009 Plitron Inc.'

### Email Fault Alert Notification

In the unlikely event your AVR experiences an issue, the AVR will shut

down and send an email notification if this section is configured. After entering the configuration parameters use the 'Send Test Email' button to confirm your settings are correct.

The screenshot shows the 'Set Password' page of the Torus Power AVR software. The navigation menu on the left is the same as in the previous screenshots, with 'Set Password' highlighted. The main content area is titled 'Set Password' and includes a sub-header 'Torus Power AVR'. The configuration area contains two text input fields: 'Enter New Password:' and 'Re-enter Password:'. A 'Save Password' button is located below the second field. At the bottom of the page, there is a copyright notice: 'Copyright © 2009 Plitron Inc.'

### Set Password

If you wish to change the password, use this screen.

#### *In case your forget your new*

**password**, you can restore the AVR to factory default password by pressing the button on the front of the AVR unit and *HOLDING* it down for at least 10 seconds. The default password is **avr**.

## AVR Software - Menu Selections (continued)

Torus Power AVR

- AVR Status
- Switch Power
- Setup
- Email Configuration
- Set Password
- Torus Power Home
- Network Configuration

### AVR Network Configuration

This page allows the configuration of the AVR's network settings.

**CAUTION:** Incorrect settings may cause the AVR to lose network connectivity. Recovery options will be provided on the next page.

Enter the new settings for the AVR below:

<b>MAC Address:</b>	<input type="text" value="00:50:C2:B5:D1:36"/>
<b>Host Name:</b>	<input type="text" value="AVR"/>
	<input checked="" type="checkbox"/> Enable DHCP
<b>IP Address:</b>	<input type="text" value="192.168.1.100"/>
<b>Gateway:</b>	<input type="text" value="192.168.1.1"/>
<b>Subnet Mask:</b>	<input type="text" value="255.255.255.0"/>
<b>Primary DNS:</b>	<input type="text" value="192.168.1.1"/>
<b>Secondary DNS:</b>	<input type="text" value="0.0.0.0"/>
<input type="button" value="Save Config"/>	

Copyright © 2009 Plitron Inc.

Each AVR unit has a unique MAC Address which is factory assigned.

The IP address assigned to the AVR is dynamically assigned and is displayed on this screen as well as on the front panel LCD of the AVR.

The AVR can be programmed through the web browser to automatically get an IP address from the network switch or router and this is the default setting and should work on most networks. Some networks require each PC or device to use a fixed IP address and the AVR also supports this option.

### Notes:

1. The output current (Amps) displayed on the LCD is the RMS reading of the load. It does not indicate the peak current loads.
2. There is a 20-second delay built into the AVR system, to prevent nuisance switching. The AVR will take approximately 20-seconds to change relay taps to switch to the proper output voltage setting.
3. North American models (15A, 20A): Torus AVR will keep the output constant within the range of 115Volts to 125Volts, with an input voltage of 90V to 130V. Between 85V to 90V, and between 130V and 135V, the regulation will be reduced.
4. North American BAL models: Torus AVR will keep the output constant within the range of 115Volts to 125Volts, with an input voltage of 170V to 270V. Between 160V to 170V, and between 260V and 270V, the regulation will be reduced.
5. International models: Torus AVR will keep the output constant within the range of  $240 \pm 10$ Volts, with an input voltage of 170V to 270V. Between 160V to 170V, and between 260V and 270V, the regulation will be reduced.
6. A drop in the input voltage is normal when increasing the load on the Torus AVR. This is a result of the impedance of the power line, and is a function of the distance from the electrical panel.

### Switch On Delay Feature

The Automatic Voltage Regulation (AVR) feature is designed to handle normal utility fluctuations to provide the connected equipment with an optimal voltage supply. It is common when utility power is restored after a blackout that the voltage supply is unstable for a few seconds. To further protect connected equipment your AVR is equipped with a start up delay feature. When the power switch is turned on or when the power switch is on and utility power is restored, power will not be connected to the output receptacles until the delay time has passed.

# Block Diagram - AVR System

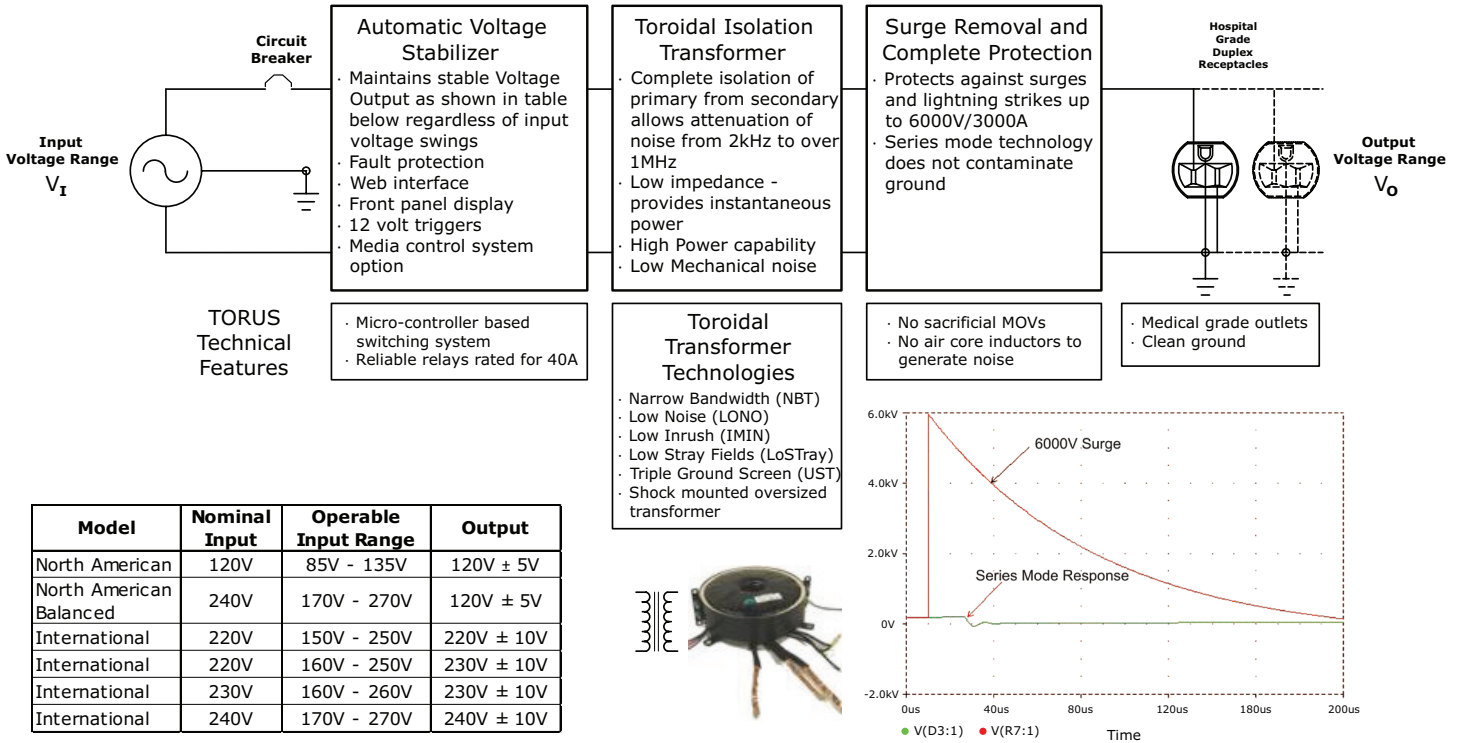

## Layout

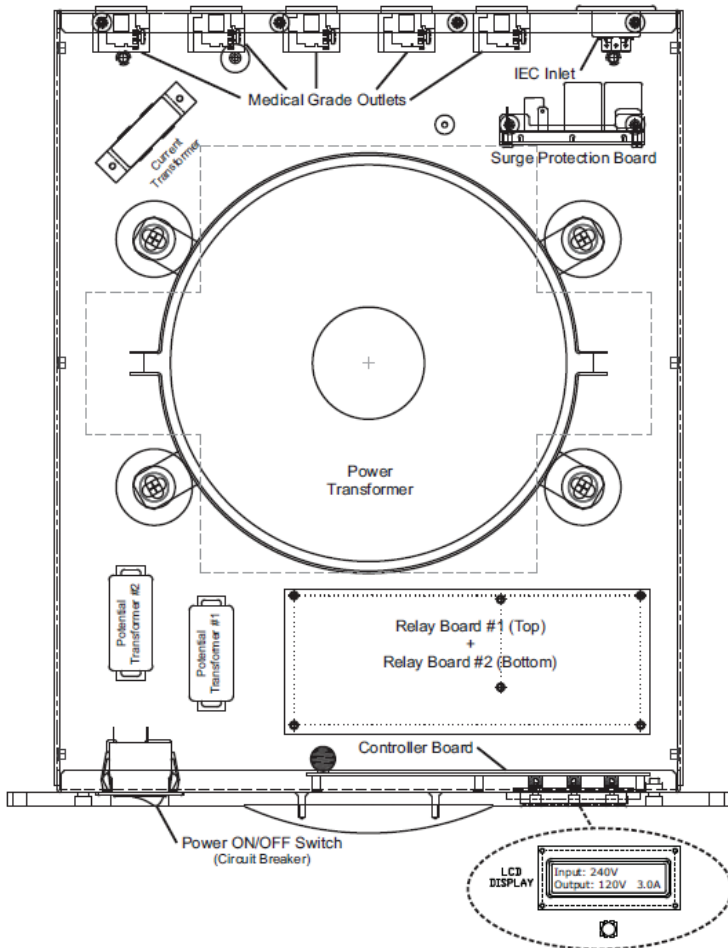

**Note:** Layout drawing is provided for reference only, Torus Power AVR units have no user serviceable parts inside. Please return unit to manufacturer for repair and service when required.

## Circuit Schematic - North American Model (AVR 20)

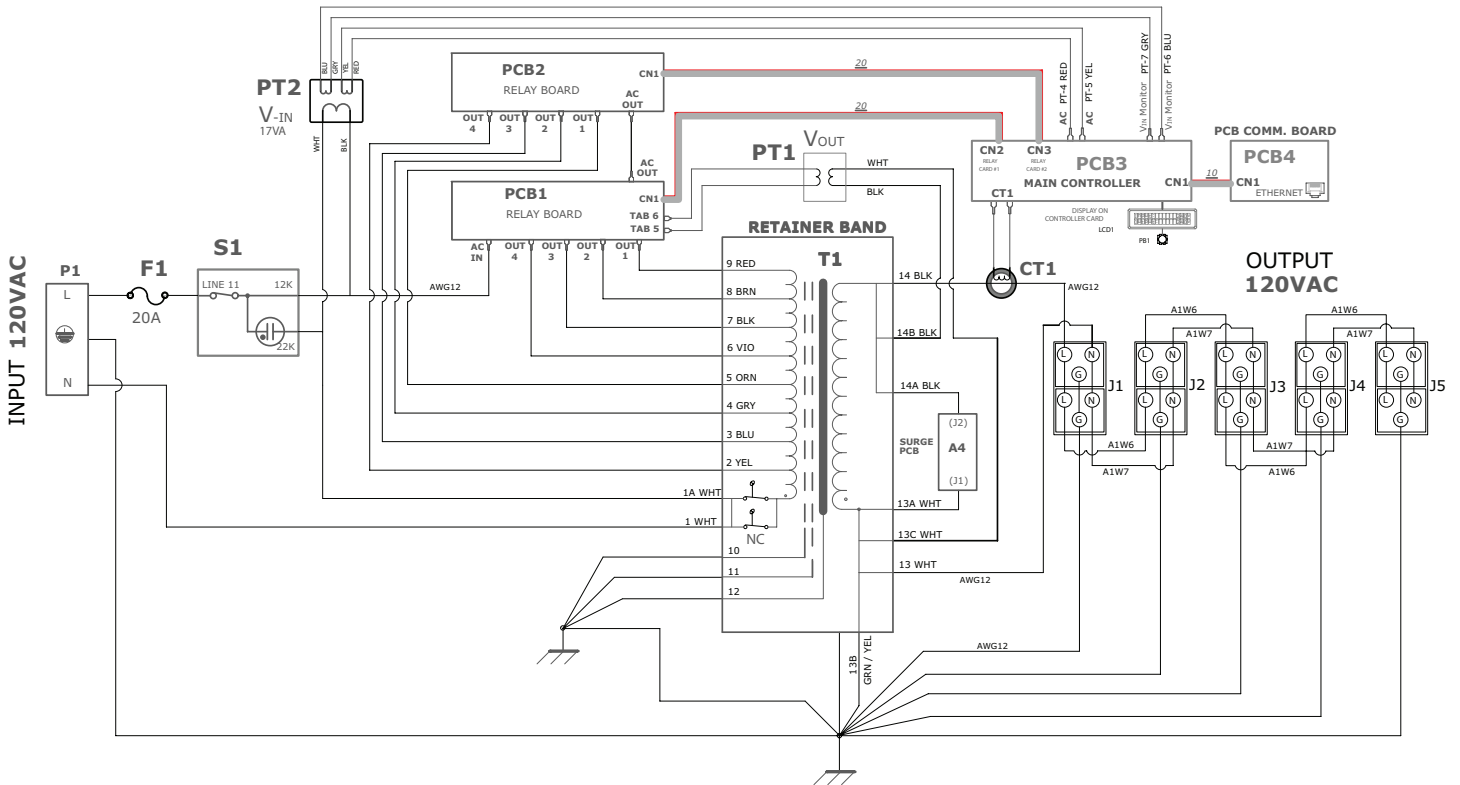

## Circuit Schematic - International Model (AVR 8 CE)

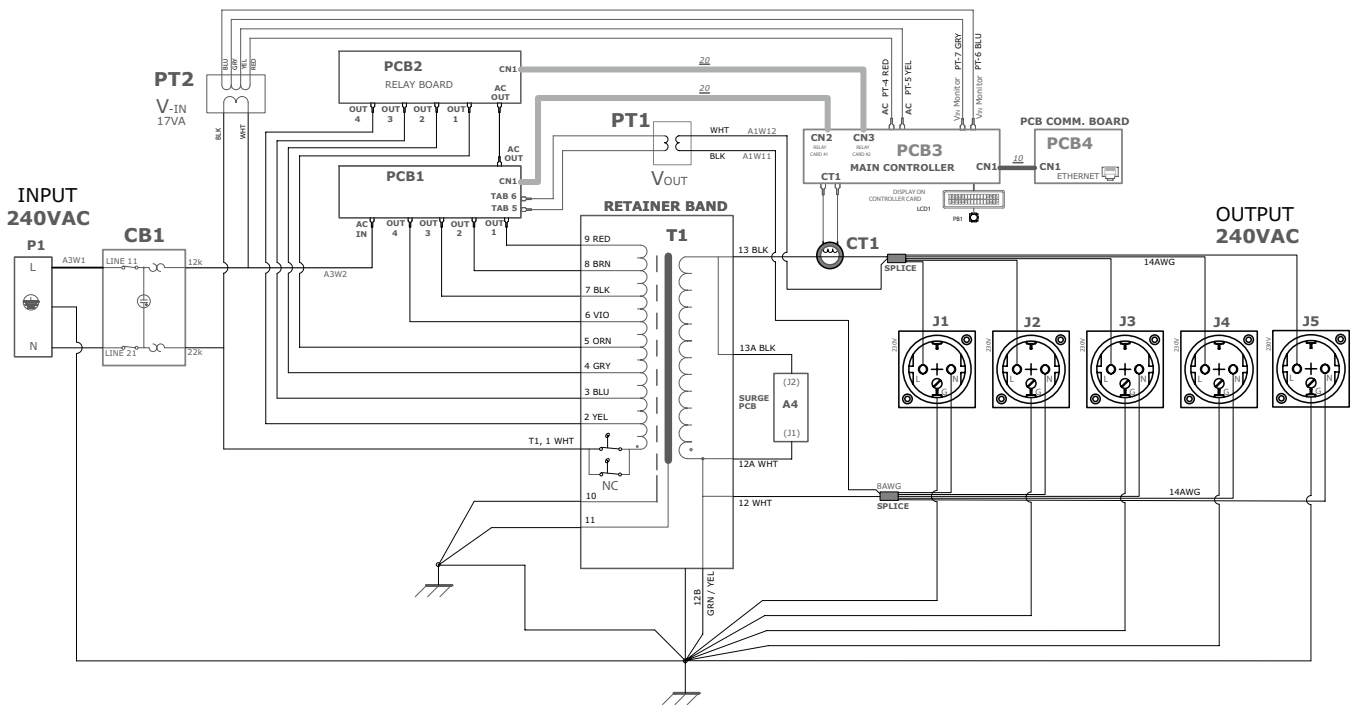

**Note:**

Circuit schematic drawing is provided for reference only, Torus Power AVR units have no user serviceable parts inside. Please return unit to manufacturer for repair and service when required.

## Electrical Specifications - North American Models

Model Number	Input Voltage Nominal	Output Voltage Nominal	Input Fuses	Maximum Available Output Current
AVR 15	120VAC, 60Hz (Operating Range 85V to 135V)	120VAC $\pm$ 5V	1 x 15A	15A
AVR 15 PLUS			1 x 15A	15A
AVR 20			1 x 20A	20A
AVR 20 BAL	240VAC, 60Hz (Operating Range 170V to 270V)	120VAC $\pm$ 5V	1 x 10A	20A
AVR 45 BAL			2 x 25A	45A
AVR 60 BAL			2 x 30A	60A
AVR 75 BAL			2 x 40A	75A
AVR 90 BAL			2 x 45A	90A

## Electrical Specifications - International Models

Model Number	Input Voltage Nominal	Output Voltage Nominal	Input Circuit Breaker (Fuses)	Maximum Available Output Current
AVR 4 CE	240VAC, 50/60Hz (Operating Range 170V to 270V)	220-240VAC $\pm$ 10V	1 x 4A	4A
AVR 8 CE			1 x 8A	8A
AVR 16 CE			1 x 16A	16A
AVR 30 CE			2 x 30A (Fuses)	30A
AVR 45 CE			2 x 45A (Fuses)	45A
AVR 4 UK	240VAC, 50/60Hz (Operating Range 170V to 270V)	220-240VAC $\pm$ 10V	1 x 4A	4A
AVR 8 UK			1 x 8A	8A
AVR 16 UK			1 x 16A	16A
AVR 30 UK			2 x 30A (Fuses)	30A
AVR 45 UK			2 x 45A (Fuses)	45A
AVR 4 AUS	240VAC, 50/60Hz (Operating Range 170V to 270V)	220-240VAC $\pm$ 10V	1 x 4A	4A
AVR 8 AUS			1 x 8A	8A
AVR 16 AUS			1 x 16A	16A
AVR 30 AUS			2 x 30A (Fuses)	30A
AVR 45 AUS			2 x 45A (Fuses)	45A
AVR 4 NEUTRIK	240VAC, 50/60Hz (Operating Range 170V to 270V)	220-240VAC $\pm$ 10V	1 x 4A	4A
AVR 8 NEUTRIK			1 x 8A	8A
AVR 16 NEUTRIK			1 x 16A	16A
AVR 30 NEUTRIK			2 x 30A (Fuses)	30A
AVR 45 NEUTRIK			2 x 45A (Fuses)	45A
AVR 4 IEC	240VAC, 50/60Hz (Operating Range 170V to 270V)	220-240VAC $\pm$ 10V	1 x 4A	4A
AVR 8 IEC			1 x 8A	8A
AVR 16 IEC			1 x 16A	16A
AVR 30 IEC			2 x 30A (Fuses)	30A
AVR 45 IEC			2 x 45A (Fuses)	45A
AVR 4 615R	240VAC, 50/60Hz (Operating Range 170V to 270V)	220-240VAC $\pm$ 10V	1 x 4A	4A
AVR 8 615R			1 x 8A (Fuse)	8A
AVR 16 620R			1 x 16A	16A
AVR 30 620R			2 x 30A (Fuses)	30A
AVR 45 620R			2 x 45A (Fuses)	45A

## Electrical Specifications - International Models (Continued)

Model Number	Input Voltage Nominal	Output Voltage Nominal	Input Circuit Breaker (Fuses)	Maximum Available Output Current
AVR 15 JP	100VAC, 50/60Hz (Operating Range 85V to 135V)	100VAC $\pm$ 5V	1 x 15A (Fuse)	15A
AVR 20 JP	100VAC, 50/60Hz (Operating Range 85V to 135V)	100VAC $\pm$ 5V	1 x 20A (Fuse)	20A

## Mechanical Specifications - North American Models

Model Number	Input Connector (Rear Panel)	Output Connector (Rear Panel)	Line Cord	Size, mm (WxDxH) Size, inch (WxDxH)	Weight KG(lb)	Chassis Height
AVR 15	IEC 15A Inlet, NEMA C14	10 Medical Grade Outlets, 15A	N5/15, 14AWG-C13, 15A/125V	483x483x102 19x19x4	26 (57)	2U (3.50")
AVR 15 PLUS	IEC 20A Inlet, NEMA C20	10 Medical Grade Outlets, 15A	N5/15, 12AWG-C19, 20A/125V	483x483x203 19x19x8	36.3 (80)	4U (7.00")
AVR 20		10 Medical Grade Outlets, 20A	N5/20, 12AWG-C19, 20A/125V		40(88)	
AVR 20 BAL			N6/15, 14AWG-C19, 15A/125V		40(88)	
AVR 45 BAL	Hubbell Twist-lock 30A/250V NEMA L6-30P	18 Medical Grade Outlets, 20A	Twist-lock, 2.5M 10AWG, 30A	483x559x249 19x22x9.8	62.5(138)	5U (8.75")
AVR 60 BAL					74.5(164)	
AVR 75 BAL	Hubbell Twist-lock 50A/250V 2P3W	24 Medical Grade Outlets, 20A	Twist-lock, 2.5M 6AWG, 50A	483x660x249 19x26x9.8	88.5 (195)	
AVR 90 BAL					90.5 (200)	

## Mechanical Specifications - International Models

Model Number	Input Connector (Rear Panel)	Output Connector (Rear Panel)	Line Cord	Size, mm (WxDxH) Size, inch (WxDxH)	Weight KG(lb)	Chassis Height
AVR 4 CE	IEC 15A Inlet, NEMA C14	16A/250V CE Socket (x4)	10A/250VAC, 2.5M Plug: CEE 7/7 Connector: IEC-C13	483x483x102 19x19x4	24.5(54)	2U (3.50")
AVR 8 CE		16A/250V CE Socket (x5)		483x483x203 19x19x8	38(84)	4U (7.00")
AVR 16 CE	IEC 20A Inlet, NEMA C20	16A/250V CE Socket (x8)	16A/250VAC, 2.5M Plug: CEE 7/7 Connector: IEC-C19	483x559x249 19x22x9.8	56(123)	5U (8.75")
AVR 30 CE	Hubbell Twist-lock 30A/250V NEMA L6-30P	16A/250V CE Socket (x8)	Twist-lock, 2.5M 10AWG, 30A		85.5(188.5)	
AVR 45 CE				Hubbell Twist-lock 50A/250V 2P3W	16A/250V CE Socket (x12)	

## Mechanical Specifications - International Models (Continued)

Model Number	Input Connector (Rear Panel)	Output Connector (Rear Panel)	Line Cord	Size, mm (WxDxH) Size, inch (WxDxH)	Weight KG(lb)	Chassis Height
AVR 4 UK	IEC 15A Inlet, NEMA C14	13A/250V UK Socket (x3)	10A/250VAC, 2.5M Plug: BS 1363 Connector: IEC-C13	483x483x102 19x19x4	24.5(54)	2U (3.50")
AVR 8 UK		13A/250V UK Socket (x5)		483x483x203 19x19x8	38(84)	4U (7.00")
AVR 16 UK	IEC 20A Inlet, NEMA C20	13A/250V UK Socket (x7)	13A/250VAC, 2.5M Plug: BS 1363 Connector: IEC-C19	483x559x249 19x22x9.8	56(123)	5U (8.75")
AVR 30 UK	Hubbell Twist-lock 30A/250V NEMA L6-30P	13A/250V UK Socket (x7)	Twist-lock, 2.5M 10AWG, 30A		85.5(188.5)	
AVR 45 UK	Hubbell Twist-lock 50A/250V 2P3W	13A/250V UK Socket (x8)	Twist-lock, 2.5M 6AWG, 50A		100(220)	
AVR 4 AUS	IEC 15A Inlet, NEMA C14	10A/250V AUS Socket (x3)	10A/250VAC, 2.5M Plug: AS/NZS 3112:2000 Connector: IEC-C13	483x483x102 19x19x4	24.5(54)	2U (3.50")
AVR 8 AUS		10A/250V AUS Socket (x5)		483x483x203 19x19x8	38(84)	4U (7.00")
AVR 16 AUS	IEC 20A Inlet, NEMA C20	20A/250V AUS Socket (x7)	13A/250VAC, 2.5M Plug: BS 1363 Connector: IEC-C19	483x559x249 19x22x9.8	56(123)	5U (8.75")
AVR 30 AUS	Hubbell Twist-lock 30A/250V NEMA L6-30P	20A/250V AUS Socket (x7)	Twist-lock, 2.5M 10AWG, 30A		85.5(188.5)	
AVR 45 AUS	Hubbell Twist-lock 50A/250V 2P3W	20A/250V AUS Socket (x8)	Twist-lock, 2.5M 6AWG, 50A		100(220)	
AVR 4 NEUTRIK	IEC 15A Inlet, NEMA C14	16A/250V NEUTRIK Socket (x4)	10A/250VAC, 2.5M	483x483x102 19x19x4	24.5(54)	2U (3.50")
AVR 8 NEUTRIK		16A/250V NEUTRIK Socket (x8)		483x483x203 19x19x8	38(84)	4U (7.00")
AVR 16 NEUTRIK	IEC 20A Inlet, NEMA C20	16A/250V NEUTRIK Socket (x12)	13A/250VAC, 2.5M	483x559x249 19x22x9.8	56(123)	5U (8.75")
AVR 30 NEUTRIK	Hubbell Twist-lock 30A/250V NEMA L6-30P		Twist-lock, 2.5M 10AWG, 30A		85.5(188.5)	
AVR 45 NEUTRIK	Hubbell Twist-lock 50A/250V 2P3W		16A/250V NEUTRIK Socket(x16)		Twist-lock, 2.5M 6AWG, 50A	
AVR 4 IEC	IEC 15A Inlet, NEMA C14	10A/250V IEC Socket (x6)	10A/250VAC, 2.5M	483x483x102 19x19x4	24.5(54)	2U (3.50")
AVR 8 IEC	IEC 15A Inlet, NEMA C14	10A/250V IEC Socket (x8)	10A/250VAC, 2.5M	483x483x203 19x19x8	38(84)	4U (7.00")
AVR 16 IEC	IEC 20A Inlet, NEMA C20	10A/250V IEC Socket (x8) 16A/250V IEC Socket (x4)	13A/250VAC, 2.5M	483x559x249 19x22x9.8	56(123)	5U (8.75")
AVR 30 IEC	Hubbell Twist-lock 30A/250V NEMA L6-30P		Twist-lock, 2.5M 10AWG, 30A		85.5(188.5)	
AVR 45 IEC	Hubbell Twist-lock 50A/250V 2P3W		Twist-lock, 2.5M 6AWG, 50A		100(220)	

## Mechanical Specifications - International Models (Continued)

Model Number	Input Connector (Rear Panel)	Output Connector (Rear Panel)	Line Cord	Size, mm (WxDxH) Size, inch (WxDxH)	Weight KG(lb)	Chassis Height
AVR 4 615R	IEC 15A Inlet, NEMA C14	8 Medical Grade Outlets, 15A	N5/15, 14AWG-C13, 2.5M	483x483x102 19x19x4	24.5(54)	2U (3.50")
AVR 8 615R	IEC 20A Inlet, NEMA C20	10 Medical Grade Outlets, 15A	N5/15, 12AWG-C19, 2.5M	483x483x203 19x19x8	38(84)	4U (7.00")
AVR 16 620R	IEC 20A Inlet, NEMA C20	12 Medical Grade Outlets, 20A	N5/20, 12AWG-C19, 2.5M	483x559x249 19x22x9.8	56(123)	5U (8.75")
AVR 30 620R	Hubbell Twist-lock 30A/250V NEMA L6-30P	18 Medical Grade Outlets, 20A	Twist-lock, 2.5M 10AWG, 30A		85.5(188.5)	
AVR 45 620R	Hubbell Twist-lock 50A/250V 2P3W	24 Medical Grade Outlets, 20A	Twist-lock, 2.5M 6AWG, 50A	483x660x249 19x26x9.8	100(220)	
AVR 15 JP	IEC 15A Inlet, NEMA C14	10 Medical Grade Outlets, 15A	N5/15, 14AWG-C13, 15A/125V	483x483x102 19x19x4	26 (57)	2U (3.50")
AVR 20 JP	IEC 20A Inlet, NEMA C20	10 Medical Grade Outlets, 20A	N5/20, 12AWG-C19, 20A/125V	483x483x203 19x19x8	40(88)	4U (7.00")

### Circuit Protection

The Front panel power switch is appropriately fused and hence it prevents excessive current from entering the PIU.

### Thermal Protection

Torus Power PIU will shut down if internal unit temperature reached excessive levels.

## Typical Front Panel Layout - North American and International Models

### 19" Pro Series Rack Mount (RK) Faceplate

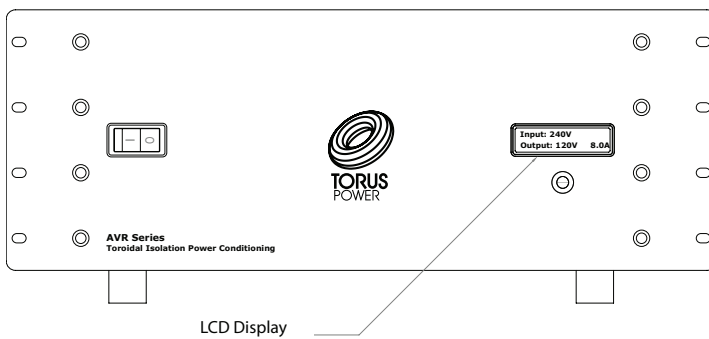

### 17" Consumer Series (C) Faceplate available in Black (B) and Silver (S)

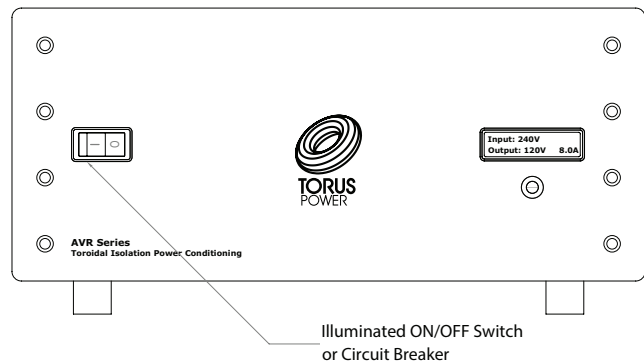



# Rear Panel Layout - North American Models

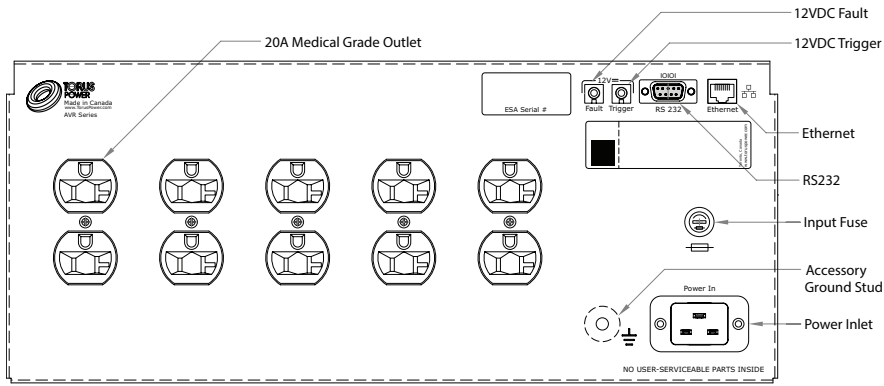

Models: AVR 20 RK, AVR 20 CB, AVR 20 CS  
 Balanced Models: AVR 20 BAL RK, AVR 20 BAL CB, AVR 20 BAL CS

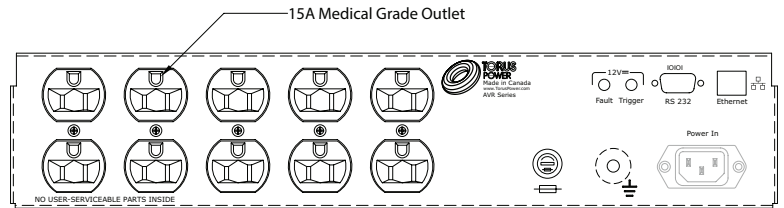

Models: AVR 15 RK, AVR 15 CB, AVR 15 CS

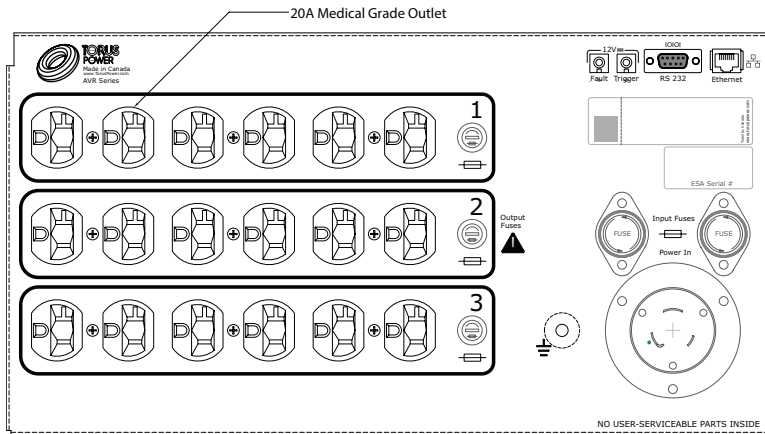

Balanced Models: AVR 45 BAL RK, AVR 45 BAL CB, AVR 45 BAL CS  
 AVR 60 BAL RK, AVR 60 BAL CB, AVR 60 BAL CS

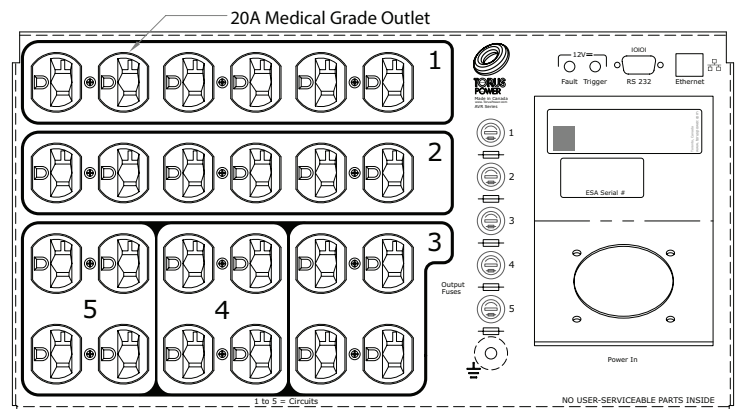

Balanced Models: AVR 75 BAL RK, AVR 75 BAL CB, AVR 75 BAL CS  
 AVR 90 BAL RK, AVR 90 BAL CB, AVR 90 BAL CS

# Rear Panel Layout - International Models

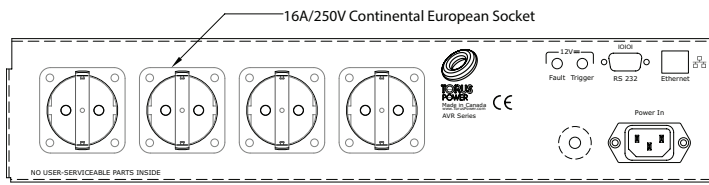

**Continental Europe 4A**  
Models: AVR 4 CE RK, AVR 4 CE CB, AVR 4 CE CS

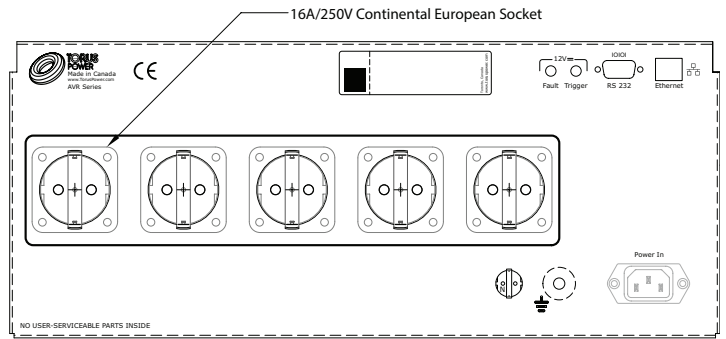

**Continental Europe 8A**  
Models: AVR 8 CE RK, AVR 8 CE CB, AVR 8 CE CS

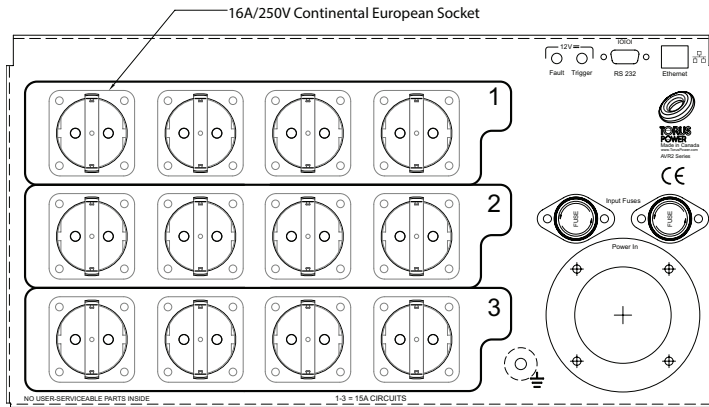

**Continental Europe 30A**  
Models: AVR 30 CE RK, AVR 30 CE CB, AVR 30 CE CS

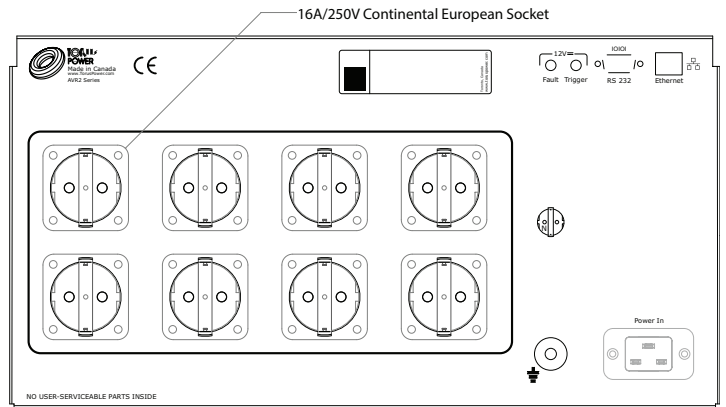

**Continental Europe 16A**  
Models: AVR 16 CE RK, AVR 16 CE CB, AVR 16 CE CS

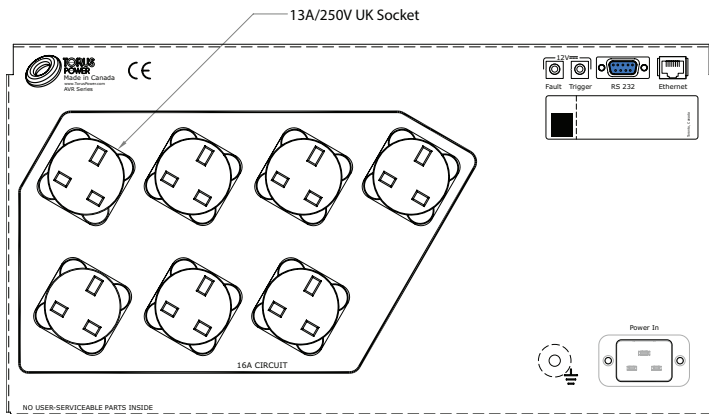

**United Kingdom 16A**  
Models: AVR 16 UK RK, AVR 16 UK CB, AVR 16 UK CS

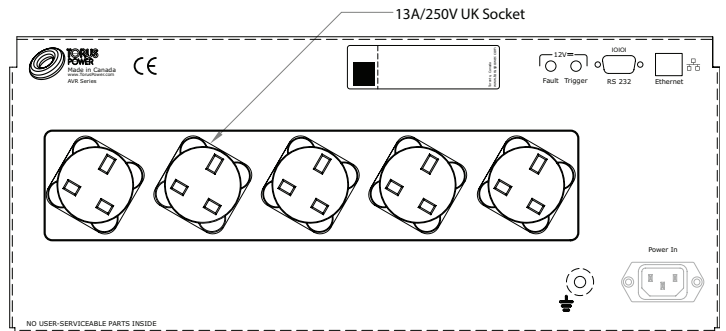

**United Kingdom 8A**  
Models: AVR 8 UK RK, AVR 8 UK CB, AVR 8 UK CS

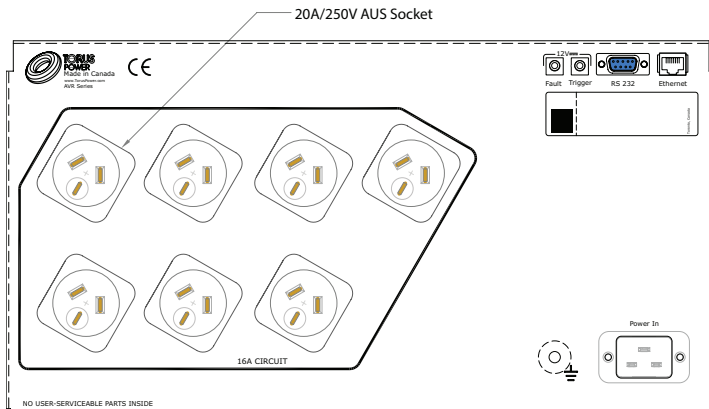

**Australian 16A**  
Models: AVR 16 AUS RK, AVR 16 AUS CB, AVR 16 AUS CS

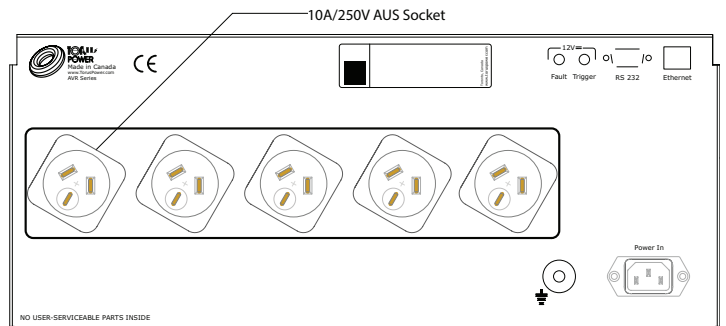

**Australian 8A**  
Models: AVR 8 AUS RK, AVR 8 AUS CB, AVR 8 AUS CS

## Home Automation Interface through RS232

---

### Serial Port Settings

9600 baud

8 data bits

No parity

Commands are terminated with the carriage return character (13 decimal).

Command	Description	Response
"C0<CR>"	Turn power OFF	"OK<CR>"
"C1<CR>"	Turn power ON	"OK<CR>"
Other Commands	Not supported	"ERROR<CR>"

### Warranty

---

Torus Power products are warranted to be free from manufacturing defects for five years from the original date of sale. This includes parts, labour and return shipping to the first registered owner and all subsequent registered owners. Warranty coverage is extended to applicable products registered or having proof-of-purchase (sales invoice, etc.).

In the event of a defect or malfunction, Torus Power will remedy the problem by repair or replacement, as we deem necessary, to

restore the product to full performance.

This warranty is considered void if the defect, malfunction or failure of the product or any component part was caused by damage (not resulting from a defect or malfunction) or abuse while in the possession of the customer. Failure to fully comply with Torus Power operating instructions, voids the warranty.

Torus Power products are marketed worldwide through Plitron Manufacturing Inc.

**For sales contact:**

[torussales@plitron.com](mailto:torussales@plitron.com)

Phone: 416-667-9914

Fax: 416-667-8928

Toll free: 1-800-754-8766

**Technical inquiries:**

[torustechnical@plitron.com](mailto:torustechnical@plitron.com)

Phone: 416-667-9914



# TORUS POWER

Engineered to perform  
& protect like no other

**Toroidal Isolation  
Power Transformers**

**Torus Power**

#8 601 Magnetic Drive Toronto,  
ON M3J 3J2  
Canada

[www.TorusPower.com](http://www.TorusPower.com)

Specifications subject to change without notice.  
© Torus Power 2015

Rev. 08/19/2015